



Vietnamese-German University

COPYRIGHT WARNING

This paper is protected by copyright. You are advised to print or download **ONE COPY** of this paper for your own private reference, study and research purposes. You are prohibited having acts infringing upon copyright as stipulated in Laws and Regulations of Intellectual Property, including, but not limited to, appropriating, impersonating, publishing, distributing, modifying, altering, mutilating, distorting, reproducing, duplicating, displaying, communicating, disseminating, making derivative work, commercializing and converting to other forms the paper and/or any part of the paper. The acts could be done in actual life and/or via communication networks and by digital means without permission of copyright holders.

The users shall acknowledge and strictly respect to the copyright. The recitation must be reasonable and properly. If the users do not agree to all of these terms, do not use this paper. The users shall be responsible for legal issues if they make any copyright infringements. Failure to comply with this warning may expose you to:

- Disciplinary action by the Vietnamese-German University.
- Legal action for copyright infringement.
- Heavy legal penalties and consequences shall be applied by the competent authorities.

The Vietnamese-German University and the authors reserve all their intellectual property rights.



Master's Thesis

Topic: Nitrous oxide
emissions during
wastewater treatment
process



Student: Nguyen Phuong Dung

Supervised by: Prof.Dr.-Ing.habil. Martin Wagner
MSc. Jana Trippel

Summer semester, 2022

Submission date: December 21, 2022

TASK FORMULATION

Nitrous oxide emissions during wastewater treatment process



Task formulation for the Master 's thesis by
Ms. Nguyen Phuong Dung, Matriculation-Nr.: 18950

Institute IWAR
Chair of Wastewater Technology
Prof. Dr.-Ing. habil. M. Wagner

22. Juni 2022

Climate-relevant gases are also produced in the field of biological wastewater treatment - in particular nitrous oxide (N_2O) during nitrogen conversion. The climate relevance of wastewater treatment as a whole is classified as rather low, but the potential for saving climate-relevant gases in the sense of achieving sustainable water quality management has been investigated and estimated worldwide. Nevertheless, nitrous oxide emissions are of relevance, as N_2O has a greenhouse potential of 265 to 298 times higher than the gas CO_2 . The direct emission of N_2O from municipal wastewater treatment plants mainly originates from the biological stage, where N_2O is formed as a by-product of nitrogen removal via nitrification and denitrification process. Previous studies have identified nitrification process as most relevant of N_2O formation.

Most of the N_2O produced is immediately emitted into the atmosphere through the aeration system, especially when a fine bubble system is installed. Nitrous oxide production during the aerated phase or the aerated part of an aeration tank is linked to the ammonium oxidation. Therefore, load fluctuations of the nitrogen influent load between day and night show a clear influence on the produced and emitted N_2O load. A decrease of the dissolved N_2O concentration in the activated sludge could be proven by denitrification process so far. In addition, several operational factors influencing N_2O production and formation have already been detected, such as e.g. the efficiency of nitrogen removal and the loading conditions like sludge age and/or the F/M-ratio in the aeration tank.

The aim of the thesis is to determine and to describe the conditions under which N_2O is produced, as well as in which way a wastewater treatment plant should be operated in order to produce as low N_2O as possible.

Ms Nguyen Phuong Dung is to conduct a literature survey on the following items as part of her Master's thesis:

- Overview of the formation of N_2O at the microbial level during biological wastewater treatment,
- Under which conditions and with which processes is nitrous oxide formed during biological wastewater treatment and in what order of magnitude,
- Differences by different boundary conditions (waste water composition, water temperature, etc.),
- Differences between various wastewater treatment processes (CASP, MBBR, etc.) with comparison of the individual processes,
- Sensible recording during operation (current state of research),
- Existing balancing of N_2O emissions and calculation models,
- Approaches to prevent production.

Vietnamese-German University

In the course of scientific work, the collected and/or used data, results and evaluations must be made available to the supervisors in a form that third parties can understand, including the thesis as Word and PDF files. The scope of the thesis is 24 CP with a processing period of 26 weeks. Finally, the thesis is presented in the form of a 20-minute presentation.

Supervising Professor:



Prof. Dr.-Ing. habil. Martin Wagner

Contact Person:



Jana Trippel, M.Sc.

ABSTRACT

Nitrous oxide (N_2O) is considered as one of the greenhouse gases emitted from municipal wastewater treatment plants and causes global warming effects. In this thesis, the overview of N_2O emissions during biological treatment processes shall be introduced according to previous literature reviews, and methodologies to reduce N_2O production would be proposed. In general, N_2O is generated from biological treatment processes through three main pathways: NH_2OH oxidation, nitrifier denitrification, and heterotrophic denitrification with the catalyst of ammonia-oxidizing bacteria, nitrate oxidizing bacteria, and denitrifying bacteria. Boundary conditions such as initial ammonium, dissolve oxygen, nitrite concentration, carbon sources, transient anoxic-aerobic conditions, temperature, pH, and phosphorus concentrations affect the amount of N_2O emitted during wastewater treatment. Although the attached growth system, nitrification-denitrification, and aerobic granular processes show their advantages in saving space and energy, N_2O production from these processes is still higher than that of the conventional activated sludge process. Various methods to estimate, measure, and calculate N_2O emissions have been illustrated, from using capita protein to directly measured by sensors to calculate N_2O generated. Finally, based on the knowledge of emission pathways, operation parameters, and calculation models have been discovered, approaches to prevent and reduce N_2O production in wastewater treatment plants would be introduced, such as dissolved oxygen and aeration control, carbon source addition, pH, temperature control and magnetic field creation, optimizing living conditions for denitrifying bacteria, inlet and initial ammonium concentration control, and long-term monitoring.

TABLE OF CONTENTS

TASK FORMULATION.....	
ABSTRACT.....	i
TABLE OF CONTENTS	ii
LIST OF ABBREVIATIONS	v
LIST OF FIGURES	vii
LIST OF TABLES	viii
INTRODUCTION.....	1
CHAPTER 1: An overview of the formation of N₂O at the microbial level during biological wastewater treatment.	3
1.1. A cycle of biological nitrogen conversions.....	3
1.2. Microorganisms and enzymes involve in the N ₂ O formation	4
1.2.1. N ₂ O from microorganisms related to nitrification	5
1.2.1.1. Nitrification – an overview	5
1.2.1.2. Types of microorganisms and enzymes in nitrification process	5
1.2.2. N ₂ O from microorganisms related to denitrification.....	10
CHAPTER 2: Conditions and emissions pathways of nitrous oxide during biological wastewater treatment.	12
2.1. Pathways and processes produce N ₂ O in wastewater treatment	12
2.1.1. Nitrifier denitrification.....	14
2.1.2. Hydroxylamine oxidation	14
2.1.3. Heterotrophic denitrification.....	16
2.2. Dominant process.....	17
CHAPTER 3: Differences by different boundary conditions.	20
3.1. Initial ammonium.....	20
3.2. Dissolved oxygen (DO) and Nitrite concentration.....	22

3.2.1.	DO.....	22
3.2.2.	Nitrite.....	23
3.2.3.	DO and Nitrite combination effect.....	24
3.3.	Carbon sources.....	26
3.4.	Transient anoxic–aerobic conditions	28
3.5.	Temperature and pH	29
3.6.	Phosphorus concentration	32
3.7.	Summary of boundary conditions	34
CHAPTER 4: Differences between various wastewater treatment processes.....		37
4.1.	Comparison of N ₂ O emission from conventional activated sludge (suspended) and biofilm (attached) system.....	37
4.1.1.	An overview of suspended and attached growth system.....	37
4.1.2.	The differences of biofilm thickness in nitrifying biofilms and denitrifying biofilms	38
4.2.	Comparison of nitrification – denitrification and traditional nitrification - denitrification	41
4.3.	Comparison of conventional activated sludge (CAS) and aerobic granular sludge (AGS).	43
4.4.	Summary of process comparisons.....	45
CHAPTER 5: Current research on N₂O emission measuring and calculation models. .		47
5.1.	N ₂ O emission estimation methods based on capita protein consumption.....	47
5.1.1.	Estimation method by Seema Das (2011).....	47
5.1.2.	Estimation method by IPCC (2019).....	48
5.2.	Measuring methods	53
5.2.1.	Off-gas measuring methods	54
5.2.2.	Dissolved gas measuring methods	57
5.2.2.1.	Stripping gas method	57

5.2.2.2.	Clark-type electrode utilizing method.....	58
5.3.	Summary of calculation methods.....	62
CHAPTER 6: Approaches to prevent production		63
6.1.	DO and aeration control.....	63
6.2.	Carbon source addition	64
6.3.	Other conditions control.....	65
6.3.1.	pH, temperature control and magnetic field creation.....	65
6.3.2.	Optimizing conditions for denitrifying bacteria.....	66
6.3.3.	Inlet and initial ammonium concentration control	66
6.3.4.	Long-term monitoring.....	66
CHAPTER 7: Discussion and conclusions.....		68
7.1.	Discussion	68
7.2.	Conclusions.....	71
SUMMARY		75
BIBLIOGRAPHY		76
APPENDIX.....		i
AFFIDAVIT		



LIST OF ABBREVIATIONS

AA/O	anaerobic/anoxic/oxic
AGS	aerobic granular sludge
AMO	ammonia monooxygenase
A/O	anoxic/oxic
AOA	ammonium-oxidizing archaea
AOB	ammonia-oxidizing bacteria
AOR	ammonia oxidation rate
AS	activated sludge
BNR	biological nutrient removal
CAS	conventional activated sludge
DCD	diethyldithiocarbamate
DFBBRs	denitrifying fluidized bed bioreactors
DNB	denitrifying bacteria
DO	dissolved oxygen
DPAOs	denitrifying phosphorus accumulating organisms
DPR	denitrifying phosphorus removal
EF	emission factor
EPA	Environmental Protection Agency
GAOs	glycogen accumulating organisms
GC	gas chromatography
GHG	greenhouse gas
HAO	hydroxylamine dehydrogenase
HET	heterotrophic denitrifiers
IPCC	Intergovernmental Panel on Climate Change
$k_{L,a}$	mass transfer coefficient
N_2OR	nitrous oxide reductase
NAR	nitrate reductase
N-DPR	nitrite-denitrifying phosphorus removal
NIR	nitrite reductase
NirK	copper-containing nitrite reductase

NOB	nitrite-oxidizing bacteria
NOR	nitric oxide reductase
NXR	nitrite oxidoreductase
OD	oxidation ditch
OLR	organic loading rate
OTR	oxygen transfer rate
PHAs	poly-b-hydroxyalkanoates
PHB	polyhydroxybutyrate
PLC	Programmable Logic Controller
PMS	phenazine methosulfate
PN/A	partial nitrification/anammox
SBR	sequencing batch reactor
SND	simultaneous nitrification and denitrification
TKN	total kjeldahl nitrogen
TN	total nitrogen
VSS	volatile suspended solids
WWTPs	wastewater treatment plants



 Vietnamese-German University

LIST OF FIGURES

Figure 1. Nitrogen conversion in biological pathway	4
Figure 2. Microorganisms and enzymes related to nitrification and denitrification.	10
Figure 3. N ₂ O emission pathways.....	13
Figure 4. The relationship between N ₂ O emission and NH ₄ ⁺ concentration.....	21
Figure 5. The relationship between N ₂ O fluxes and DO concentration.....	23
Figure 6. N ₂ O emission rate in two cases of four DO levels: with and without nitrite addition	24
Figure 7. The dependence of N ₂ O production on DO and nitrite concentrations	26
Figure 8. The contributions of N ₂ O production pathways under different DO and nitrite concentrations	26
Figure 9. The effects of temperature on the stripping of N ₂ O.....	30
Figure 10. The effects of various pH on N ₂ O production rate	31
Figure 11. The effects of pH on the AOR (a) and The relationship between AOR and N ₂ O production rate (b).....	32
Figure 12. Key parameters resulting in N ₂ O emissions	35
Figure 13. The influence of DO concentration and biofilm thickness on N ₂ O production.....	40
Figure 14. N ₂ O production of various biofilm thicknesses at different nitrate concentrations (a) and DO concentrations (b).....	41
Figure 15. A comparison of N ₂ O emission in full-nitrification and partial-nitrification.	43
Figure 16. A basic layout of off-gas measuring method.....	55
Figure 17. Collection hoods installation in off-gas monitoring.	56
Figure 18. Gas tripping device modelling.....	58
Figure 19. Clark-type electrode and measuring system	59

LIST OF TABLES

Table 1. The predominant N ₂ O generation pathways	19
Table 2. The proportion of N ₂ O accumulation per N-reduced.....	34
Table 3. Processes comparison summary	45
Table 4. Default values for municipal wastewater by regions	50
Table 5. Fraction of nitrogen removal based on treatment pathway.....	50
Table 6. Emission factor for treatment pathways in WWTPs and wastewater effluent.....	52



Vietnamese-German University

INTRODUCTION

Municipal wastewater treatment plants release three greenhouse gases: methane (CH_4), nitrous oxide (N_2O), and carbon dioxide (CO_2). Nitrous oxide is produced when biological nitrogen is removed from wastewater through nitrification and subsequent denitrification. Even small amounts can have a considerable carbon impact because the global warming effect of N_2O is 265 times more than that of carbon dioxide, which will raise the concentration of N_2O in the atmosphere and the carbon footprint of wastewater treatment plants (WWTPs). Additionally, the total global warming potential of the water cycle is increased by 26% as a result of direct N_2O emissions during wastewater treatment (Massara et al., 2017, p. 106 & 108). In terms of their overall impact on global warming, N_2O emissions from wastewater treatment plants can be very significant because they cause the stratospheric ozone layer to thin, reducing our ability to protect ourselves from harmful UV rays. They also absorb heat that would otherwise escape into the surrounding environment, changing the greenhouse effect and causing global warming. Understanding the pathways of its generation is crucial in order to develop effective mitigating measures (Thakur et al., 2019, p. 511).

Hence, the thesis aims at introducing the formation of N_2O in biological treatment in WWTPs with related conditions and proposing approaches to prevent the production. Based on hypotheses, experiments as well as conclusions of previous literature reviews, this thesis provides a comprehensive point of view on N_2O emission during biological treatment in WWTPs, including 6 chapters: i) an overview of the formation of N_2O at the microbial level, ii) Pathways and process of N_2O production, iii) differences by different boundary conditions, iv) differences between various wastewater treatment processes, v) current research on N_2O emission measuring and calculation models, and vi) approaches to prevent production. Accordingly, the three main pathways of N_2O production are nitrifier denitrification, hydroxylamine oxidation, and heterotrophic denitrification, which involves microorganisms such as ammonia-oxidizing bacteria (AOB), ammonium-oxidizing archaea (AOA), nitrite-oxidizing bacteria (NOB), and denitrifying bacteria (DNB). Various operating parameters (dissolved oxygen, nitrite, carbon source, pH, and temperature) would be discussed and indicated the key factors influencing N_2O production. Moreover, the comparison between suspended – biofilm systems, nitrification/ denitrification – traditional nitrification/denitrification, and conventional activated sludge (CAS) – aerobic granular sludge (AGS) shall be illustrated, and indicated the process emits a larger amount of N_2O than other. Especially, recent methods

of N₂O estimation according to capita protein consumption and on-site measuring methods would be shown and discussed. As a result, mitigation strategies for N₂O production would be proposed based on emission pathways, boundary conditions, and monitoring methods.



CHAPTER 1: An overview of the formation of N₂O at the microbial level during biological wastewater treatment.

Municipal wastewater treatment plants are a significant source of greenhouse gas (GHG) emissions, with N₂O, a powerful greenhouse gas generated during wastewater treatment, having gained international attention. Biological wastewater treatment is considered as the major pathway of N₂O emissions in wastewater treatment plants (Wunderlin et al., 2012, p. 1028). During biological nutrient removal, microorganisms as well as enzymes engage in the processes related to the cycle of biological nitrogen and its direction has been indicated. This chapter concentrates on producing biological nitrogen conversion, microorganisms, and enzymes involved in both nitrification and denitrification, the N₂O emission pathways during biological wastewater treatment.

1.1. A cycle of biological nitrogen conversions

For all Earth's life forms, nitrogen is necessary. Microorganisms play a crucial role in the biogeochemical nitrogen cycle by mediating nitrogen compound transformations like N₂ fixation and recycling nitrogen from decomposing biomass (Daims et al., 2016, p. 699). N₂O is primarily released during the biological nutrient removal (BNR) process in WWTPs and principally introduces the same nitrogen conversion that is typically carried out by the native microbial cultures that exist in other environments such as soil, freshwater, and marine habitats. These processes involve undergoing a transition of aerobic or anoxic reactions. Nitrification under stringent aerobic circumstances is the first phase in the two-step process of nitrogen bio-removal from wastewater, which is followed by denitrification under anoxic conditions (Thakur et al., 2019, p. 503). In WWTPs, nitrogen transformations result in the production of N₂O. This section explains the proper procedures, and Fig. 1 shows a schematic representation. First of all, NH₄⁺ is transformed to NO₂⁻ through aerobic ammonia oxidation by autotrophic and heterotrophic AOB such as *Nitrosopira*, *Nitrosomonas*, *Nitrosococcus*, (Thakur et al., 2019, p. 503) and AOA. Nitrous oxide and nitric oxide can be released during this process. Then, there are back-and-forth conversions between nitrite and nitrate called aerobic nitrite oxidation by NOB *Nitrobacter* and nitrate reduction to nitrite, respectively. NO₂⁻ is further reduced to NO catalyzed by AOB and DNB. Similarly, NO is then turned into N₂O under the influence of AOB and DNB. Finally, N₂O reduction to N₂ by DNB is the final step of the

process, but the fixation of N_2 is not relevant in most WWTPs. Furthermore, NH_4^+ combined with NO_2^- is oxidized to N_2 , which is known as Anammox (Kampschreur et al., 2009, p. 4097).

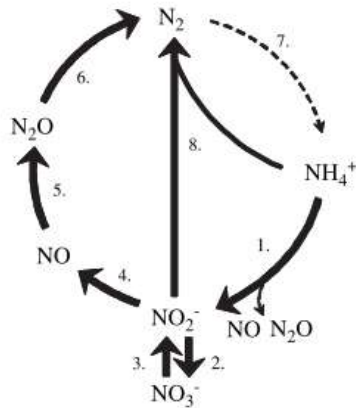

Figure 1. Nitrogen conversion in biological pathway (Kampschreur et al., 2009, p. 4097).

1.2. Microorganisms and enzymes involve in the N_2O formation

The earliest chemolithoautotrophic bacteria that grew by nitrification and used ammonia or nitrite as their energy source and electron donor were discovered by Sergei Winogradsky more than a century ago. In the course of his extensive research, Winogradsky discovered that the AOB and the NOB catalyzed the two phases of nitrification, and that their collaboration was required to complete nitrification. Additionally, he observed that both groups were slow-growing creatures in the laboratory. The biochemistry of nitrifiers from the genera *Nitrosomonas* and *Nitrobacter* illuminated the advancement of nitrification research in the subsequent century (Dworkin et al., 2012, p. 370 & 371).

The basic microbiological changes that impact N_2O production in wastewater treatment systems are covered in this section. The nitrogen cycle involves a variety of N species as well as microbial and abiotic processes, and N redox state ranges from -3 to +5. The major N species and biological changes were schematically depicted in Fig.1. The two main reactions in wastewater treatment are nitrification and denitrification, in which nitrate is successively converted to nitrogen gas. Both processes have the potential to produce N_2O (Sabba et al., 2018, p. 2 & 3).

1.2.1. N₂O from microorganisms related to nitrification

1.2.1.1. Nitrification – an overview

According to The United States Environmental Protection Agency (EPA), the microbial process of nitrification involves the progressive oxidation of ammonia to nitrite and subsequently to nitrate. Autotrophic nitrifying bacteria, which can produce organic molecules using energy from inorganic sources like ammonia or nitrite, dominate the nitrification process (EPA, 2007, p. 1).

Based on equation (1), AOB convert ammonia to nitrite in the first phase of nitrification. The genus *Nitrosomonas* has been connected to this stage the most frequently, but other species, such as *Nitrosococcus* and *Nitrospira*, could also be involved.

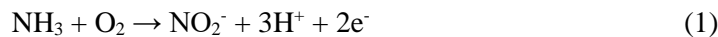

NOB convert nitrite to nitrate in the second step of the process. Despite the fact that other genera, including *Nitrospina*, *Nitrococcus*, and *Nitrospira*, can also autotrophically oxidize nitrite, *Nitrobacter* is the genus most usually related to this second phase:



1.2.1.2. Types of microorganisms and enzymes in nitrification process

Three distinct types of microbes are AOB, AOA which convert ammonia into nitrite, and NOB which transform nitrite into nitrate during nitrification. It is assumed that autotrophic AOB and NOB, using nitrite or ammonia as their energy sources and CO₂ as their carbon source, accomplish the majority of the nitrification in WWTPs. AOA can also do ammonium oxidation, found in WWTPs that were run at low dissolved oxygen levels and lengthy solid retention durations (Kampschreur et al., 2009, p. 4094).

In the nitrification pathway, while AOB and AOA oxidize ammonia to nitrite (equation 1), using hydroxylamine (NH₂OH) as an intermediate, NO₂⁻ is converted to NO₃⁻ by NOB (equation 2). Fig. 2 illustrates the nitrogen transformation and N₂O emission by AOB, NOB, and DNB. Through two key processes, nitrifier denitrification, and NH₂OH oxidation, AOB directly yield N₂O. By influencing the availability of NH₃ and NO₂⁻, NOB, AOA, anammox,

and comammox bacteria indirectly contribute to the generation of N₂O. AOB convert NO₂⁻ in the nitrifier denitrification pathway to NO and N₂O (Kim et al., 2010, p. 3958). In the NH₂OH oxidation pathway, the enzyme hydroxylamine oxidoreductase (HAO) oxidizes NH₂OH to NO, which is then reduced to N₂O by the enzyme NO reductase (NOR) (Law et al., 2012b, p. 1269).

❖ Ammonia oxidizing bacteria

AOB play an essential role in the nitrogen cycle. They catalyze the conversion of NH₃ to NO₂⁻ via hydroxylamine, which is the initial stage of nitrification. As chemolithoautotrophs, they fix CO₂ to get carbon for biosynthesis and use ammonia as their only source of energy and reducing power. Pure culture research has demonstrated that AOB also create N₂O, not only with *Nitrosomonas europaea* strains but also with *Nitrosospira* (Shaw et al., 2006, p. 214 & 215). Ammonia monooxygenase (AMO) and hydroxylamine dehydrogenase are two essential enzymes required for ammonia oxidation by AOB. AMO is a membrane-bound enzyme produced by autotrophic ammonia oxidizing bacteria. It has three sub-units (AmoA, AmoB, and AmoC). It catalyzes the oxidation of ammonia to hydroxylamine in the following reaction, which is the first step of the pathway (Holmes et al., 2019, p. 6):



Vietnamese-German University

The hydroxylamine is then oxidized to HNO₂ in the periplasm by HAO, which catalyzes the following reaction:

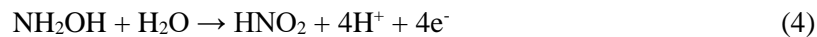

The processes and the roles of AOB in N₂O emission were clarified. Firstly, under aerated condition with ammonium NH₄⁺ or NH₂OH, a large amount of N₂O was released. However, when the nitrification substrate depleted, the emission ceased. In addition, N₂O was not released when NH₄⁺ was substituted with nitrite and nitrate. This finding proposed that the N₂O emission under nitrifying cultures was dependent on the oxidation of NH₄⁺ by AOB rather than the oxidation of NO₂⁻ by NOB or denitrification by heterotrophic denitrifiers (Kim et al., 2010, p. 3958). Secondly, studies conducted with diethyldithiocarbamate (DCD), an inhibitor of copper-containing nitrite reductase (NirK) and AMO showed that N₂O, NO₂⁻, and NO₃⁻ were not evolved because NH₄⁺ oxidation did not take place when DCD was added to the nitrifying system. This result above is consistent with the substantial suppression by inhibitors, supporting the idea that the oxidation of NH₄⁺ by AOB is directly related to N₂O emission

during nitrification processes. Thirdly, the N_2O emission rate was unaffected by further NO_3^- injection to the oxidizing sludge system containing NH_4^+ . However, the rate increased considerably with the addition of NO_2^- . NO_2^- had no effect on the oxidation of NH_4^+ because NH_4^+ dropped at the same rate as in the absence of NO_2^- , indicating that NO_2^- was the direct antecedent of N_2O , and NO_2^- was the source of N_2O from denitrification. These findings suggested that denitrification by AOB itself is the origin of N_2O emission (Kim et al., 2010, p. 3960).

❖ Nitrite oxidizing bacteria

For many years, ammonia oxidizers have been the principal subject of nitrification research because the finding of AOA has sparked interest in the field of ammonia oxidizers (Könneke et al., 2005, p. 543) and NOB are reputed to be even more challenging to grow in a laboratory than AOA or AOB. Additionally, NOB were considered to have little potential for the discovery of novel physiologies because they were obligate chemolithoautotrophs with a relatively small physiological repertory. As a result, the advancement of understanding on NOB fell behind that of other nitrogen-cycling bacteria. However, whether fixed nitrogen is lost to the atmosphere or persists in an ecosystem depends the outcome of nitrite (Daims et al., 2016, p. 699 & 700). By converting nitrite to nitrate, which is used as a nitrogen source by numerous microorganisms and plants, NOB offset nitrogen loss. Therefore, NOB play a crucial regulatory role in the nitrogen cycle. Additionally, nitrite suppresses bacterial growth and is harmful to aquatic organisms (Lewis Jr et al., 1986, p. 183). Nitrite oxidoreductase (NXR), a core enzyme of NOB, catalyzes the conversion of nitrite to nitrate (Fig. 3). NOB activity in WWTPs is frequently unstable (especially in industrial plants), and failures of nitrite oxidation can seriously harm the environment if nitrite from WWTPs seeps into freshwater sources (Daims et al., 2016, p. 700).

❖ Ammonium-oxidizing archaea

In contrast to AOB, which has well-defined N_2O generation pathways, the mechanisms underlying AOA are still poorly known (Sabba et al., 2018, p. 9817). AOA discovered in WWTPs are known to produce N_2O , most likely by similar pathways to AOB (Santoro et al., 2011, p. 1282 & 1283), despite the fact that there is not any evident signs that they have a large impact on N_2O production (Kampschreur et al., 2009, p. 4097). When low NH_3 concentrations are present in the natural environment, they are frequently the predominant ammonia-oxidizing

species (Holmes et al., 2019, p. 11). Nevertheless, a study carried out on *Nitrosopumilus maritimus* genome reveals that AOA oxidize NH_3 in a distinct way from AOB since NH_2OH has been confirmed as an intermediate, HAO has not been detected in AOA (Vajjala et al., 2013, p. 1006). Because of the structural changes in the archaeal AMO, the absence of genes encoding the hydroxylamine-ubiquinone redox module, and a periplasm enriched in redox active proteins, they are unable to create N_2O enzymatically through NH_3 oxidation or nitrifier denitrification, as is done by AOB (Walker et al., 2010, p. 8819 & 8820).

❖ Comammox bacteria

Comammox bacteria completely oxidize ammonia (comammox) by converting NH_3 to NO_3^- (Van Kessel et al., 2015, p. 1). Under ammonia-limiting situations, comammox enrichments were obtained in the laboratory since Comammox are believed to have a competitive edge over traditional ammonia oxidizers (such as AOA and AOB) (Daims et al., 2015, p. 504). Since the N_2O generation by the Comammox organism *Ca. Nitrospira inopinata* was described, and the recently-discovered full conversion of NH_3 into NO_3^- by a particular microbe, nitrospira (Comammox), has altered the conventional view of the nitrogen cycle (Daims et al., 2016, p. 708). Comammox *Nitrospira* have been found in high concentrations in soil and freshwater ecosystems, groundwater, drinking water treatment systems, and WWTPs, according to investigations of novel metagenomes (Van Kessel et al., 2015, p. 3). In a full-scale WWTP, comammox bacteria were interestingly shown to be the primary ammonia oxidizer (Daims et al., 2015, p. 507). Besides, it was also suggested that Comammox *Nitrospira* possess NH_3 and NO_2^- oxidation genome (*hao*, *amo*, and *nxr*) structurally similar to classical AOB and NOB, respectively (Daims et al., 2015, p. 505), but the identification concerning their ability to produce N_2O is limited. It was reported that the enzymes related to NO_x metabolism (cNOR, sNOR) are not present in the genomes of Comammox *Nitrospira* (Palomo et al., 2018, p. 1787). As a result, Comammox may become a disadvantage of partial nitrification/anammox (PN/A) systems that require NO_2^- production, but involving in the reduction of N_2O generation by reducing the NO_2^- accumulation. The existence of Comammox in wastewater treatment processes are currently under investigation to shed light on the potential role of comammox in N_2O production (Sabba et al., 2018, p. 9818). The exploration of comammox brought up a lot of important issues. Why does complete nitrification take place in these species but not in the other nitrifiers that are known? Was comammox neglected, causing the activity of canonical nitrifiers in varied situations to be overstated over decades? Does comammox have a role in

the generation of N_2O in both natural and engineered systems? Because of the increased energy yield per ammonia oxidized entirely to nitrate, under what circumstances does comammox outperform other nitrifiers? It is important to research how nitrification-inhibiting or hazardous substances affect comammox in order to improve nitrification monitoring in WWTPs (Daims et al., 2016, p. 708). In general, an ammonium shortage makes anammox bacteria viable. Nitrate is not reduced by Anammox bacteria via N_2O -based denitrification as in traditional denitrification. One of the anammox reaction's suggested intermediates is NO. NO detoxification may be one explanation for the generation of N_2O . Currently, it is believed that the only processes that produce N_2O are nitrification in aerobic conditions and denitrification in anoxic environments. Nonetheless, by lowering the amounts of NH_3 and NO_2^- , anammox indirectly influence N_2O production of heterotrophs and AOB. Additionally, another potential source for N_2O synthesis could come from the NO detoxification process carried out by anammox or other bacteria in the anoxic zones (Kartal et al., 2007, p. 638; Sabba et al., 2018, p. 9818).

Heterotrophic bacteria can also oxidize ammonia; however, they do not receive energy from this process. A study of Van Niel et al (1993) showed that only at organic loading rates ratio of $COD/N > 10$ and low dissolved oxygen concentrations, heterotrophic ammonia oxidation outperform autotrophic ammonia oxidation (Van Niel et al., 1993, p. 109). On the other hand, there are no signs that heterotrophic ammonia oxidizers or AOA are important in the production of N_2O in traditional activated sludge plants. For instance, a comparison of N_2O production conducted in pure cultures showed that heterotrophic nitrification (*Alcaligenes faecalis*) produces more N_2O than autotrophic nitrification (*Nitrosomonas europaea*) (Anderson et al., 1993, p. 3525).

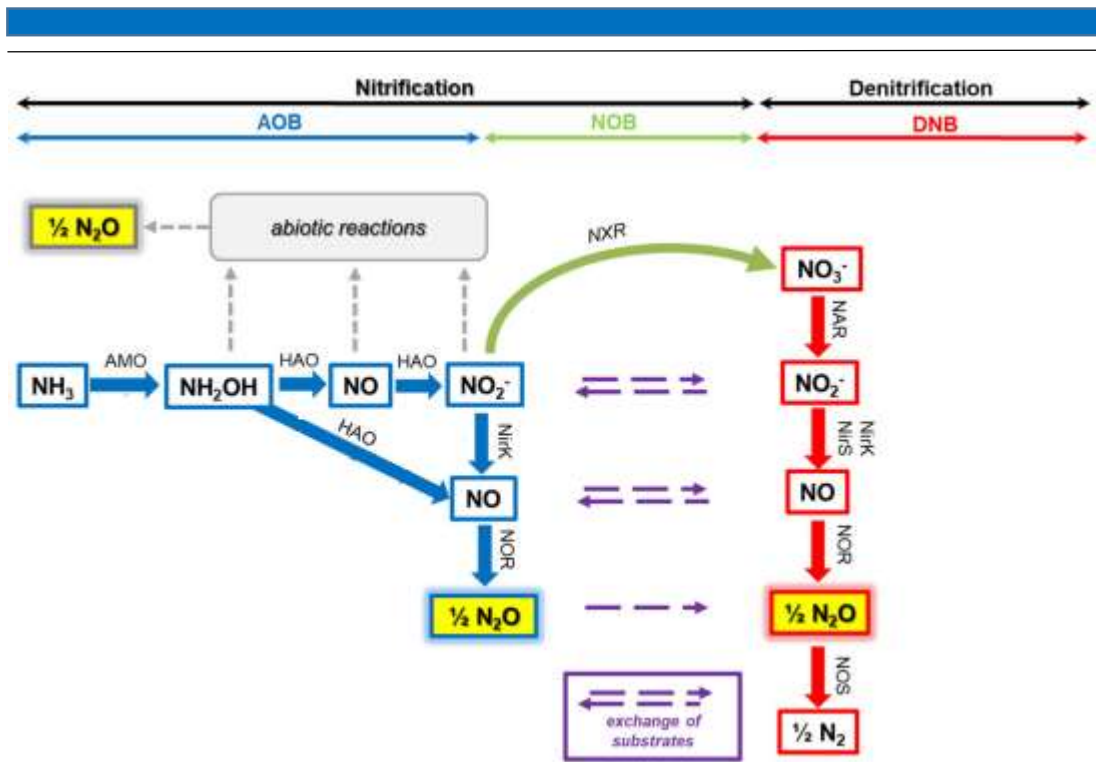

Figure 2. Microorganisms and enzymes related to nitrification and denitrification (Sabba et al., 2018, p. 9818).

1.2.2. N_2O from microorganisms related to denitrification

In the denitrification process, NO_3^- is converted subsequently to NO_2^- , NO , N_2O , and N_2 as depicted in Fig.2. The microorganisms that carry out this process are referred to as denitrifiers. They are often heterotrophic bacteria that use nitrate as an electron acceptor to decompose easily biodegradable substrate in anoxic environment. These bacteria first use oxygen for metabolism if it is present before using nitrate. Therefore, for the denitrification process to be effective, dissolved oxygen concentrations must be kept to a minimum (EPA, 2007, p. 1 & 2).

DNB involves in denitrification processes. The process of denitrification includes reducing NO_3^- and NO_2^- in order to get NO , N_2O , and then N_2 . Nitrate reductase (NAR), nitrite reductase (NIR), nitric oxide reductase (NOR), and nitrous oxide reductase (N_2OR) are the four enzymes engaged. Fig. 3 depicts a diagram of the denitrification metabolism. Selective inhibition of the N_2OR enzyme frequently results in the generation of N_2O during wastewater denitrification processes (Guo et al., 2018, p. 5). This may be due to its increased sensitivity to DO and other parameters such as pH, NO_2^- accumulation, carbon source concentration, etc...which will be discussed in chapter 3.

Generally, ammonia oxidizing bacteria, ammonium oxidizing archaea and nitrite-oxidizing bacteria convert NH_4^+ to NO_2^- and NO_3^- during nitrification. Ammonia monooxygenase and hydroxylamine oxidoreductase, respectively, catalyze the initial step in the oxidation of NH_4^+ to NO_2^- via hydroxylamine. Besides, HAO together with NirK and NOR catalyze the production of N_2O through NO_2^- and NO as intermediate. Then, NXR, the core enzyme of NOB, activate the conversion of NO_2^- to NO_3^- . During denitrification, the process of converting NO_3^- to N_2 involves the sequential action of four enzymes: nitrate reductase, nitrite reductase, nitric oxide reductase, and nitrous oxide reductase by denitrifying bacteria (Fig.2).



Vietnamese-German University

CHAPTER 2: Conditions and emissions pathways of nitrous oxide during biological wastewater treatment.

N₂O emission pathways from wastewater treatment plants have been thoroughly reviewed. It is believed that heterotrophic denitrifiers and autotrophic ammonia-oxidizing bacteria are the main producers of N₂O in wastewater treatment systems. It can be produced by AOB through incomplete NH₂OH oxidation and denitrification. A recognized intermediate in heterotrophic denitrification is N₂O. In order to produce N₂O, several processes such as nitrification, nitrifier denitrification by AOB, and heterotrophic denitrification by denitrifiers must first undergo reactions that are catalyzed by particular enzymes that are engaged in the biological process. The speed and direction of biological nitrogen cycle are controlled by these enzymes (Guo et al., 2018, p. 2). This chapter aims at illustrating N₂O emission pathways and enzymes involved as well as discussing the predominant process.

2.1. Pathways and processes produce N₂O in wastewater treatment

One question is which step in the wastewater treatment process is more responsible for N₂O emission. AOB rather than NOB are primarily responsible for producing N₂O during nitrification. Hydroxylamine oxidation, nitrifier denitrification, and other processes are the mechanisms for N₂O emission during nitrification. N₂O is a metabolic intermediary during denitrification, and its emission primarily results from incomplete denitrification. This makes the mechanism for N₂O emission during denitrification rather straightforward (L. Shen et al., 2014, p. 776).

In chapter 1, the concept of microbial related to nitrification and denitrification has been indicated. Particularly, the process of nitrification is the step-by-step autotrophic oxidation of ammonia to nitrite and then to nitrate by AOB and NOB, respectively. Whereas, denitrification involves nitrite, nitric oxide, and nitrous oxide as intermediates produced by heterotrophic denitrifiers (HET), which are the conversion of nitrate to atmospheric nitrogen. However, in this chapter, the content of N₂O emissions pathways is considered and discussed. Indeed, it could be seen from figure 2 that N₂O can emit during NH₂OH and through the transformation of NO₂⁻ by NirK and Nor (nitrification), as well as heterotrophic denitrification. According to the processes, there are primarily three biological mechanisms that lead to the production of

nitrous oxide: nitrifier denitrification, hydroxylamine (NH_2OH) oxidation, and heterotrophic denitrification (Wunderlin et al., 2012, p. 1028). To be more precise, nitrifier denitrification is the reduction of NO_2^- by AOB in the presence of ammonia, hydrogen, or pyruvate as electron donors, for example, at low oxygen or high nitrite concentrations (Wrage et al., 2001, p. 1723). Hydroxylamine oxidation is the generation of N_2O from biological hydroxylamine oxidation intermediates such as $\text{N}_2\text{O}_2\text{H}_2$ and nitrosyl radical (HNO) (Poughon et al., 2001, p. 421), which is supposed to be connected to an imbalanced metabolism of AOB, including *N. eutropha*, *N. europaea*, and several *Nitrosospira* spp., utilizing NO_2^- as an alternate electron acceptor, dimeric nitrogen dioxide (N_2O_4), produce N_2O and NO , but not N_2 (Yu et al., 2010b, p. 1315), or by chemical breakdown of hydroxylamine called chemodenitrification. The NH_2OH oxidation is further divided into two processes happened simultaneously, which are the conversion of NH_2OH to HNO and of HNO to NO_2^- through the unstable breakdown of NOH (Law et al., 2012b, p. 1270). Heterotrophic denitrification is the process of heterotrophic denitrifiers forming N_2O as a result of an nitrogen-reducing enzymes under imbalanced activity conditions, for example, NO_2^- accumulation and the presence of oxygen. N_2O emissions pathways were depicted in Fig. 3.

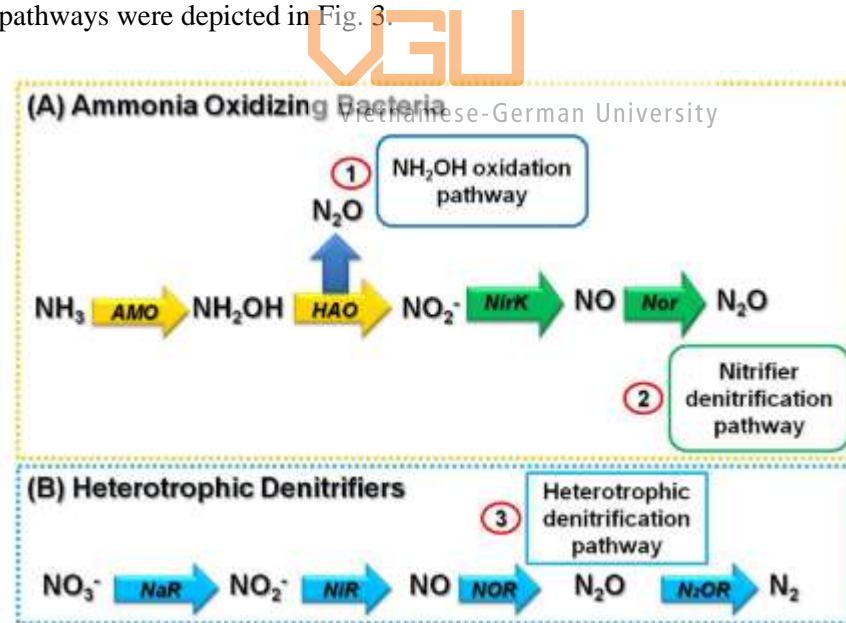

Figure 3. N_2O emission pathways (Massara et al., 2017, p. 109).

2.1.1. Nitrifier denitrification

The process of nitrifier denitrification involves autotrophic AOB converting NO_2^- to NO , N_2O , and N_2 . However, the genome of AOB only contains the genes for NO_2^- and NO reductase (*nirK* and *norB*), but not for N_2O reductase. This shows that the nitrifier denitrification pathway's outcome is N_2O rather than N_2 . Particularly in anoxic to suboxic circumstances, the nitrifier denitrification pathway is crucial for the formation of N_2O by AOB. Nitrifier denitrification can contribute up to 83% of the N_2O emissions, depending on the DO level, according to experiments done with full-scale sludge (Law et al., 2012b, p. 1269). Additionally, according to Kim et al. (2010), the primary source of N_2O in an activated sludge under nitrifying conditions comes from the denitrification activity by AOB (Kim et al., 2010, p. 3960).

2.1.2. Hydroxylamine oxidation

Fig.3 showed the N_2O emission pathway during hydroxylamine oxidation. An ammonia monooxygenase that is membrane-bound first converts NH_3 to NH_2OH . A pair of electrons and molecular oxygen are needed for this first step. Hydroxylamine oxidoreductase (HAO) performs the next step in the periplasm to produce NO_2^- and two pairs of electrons, the first pair supports the initial NH_3 oxidation, whereas the second pair is employed to produce energy (Law et al., 2012b, p. 1270). In addition, in order to define the structure and function of HAO, the NH_2OH oxidation is further divided into two processes that enable the simultaneous acceptance and transfer of two electrons. NH_2OH is converted to HNO and HNO is transformed to NO_2^- simultaneously. HAO activity can produce both N_2O and NO through the unstable HNO , an enzyme-bound intermediate (Igarashi et al., 1997, p. 282). Furthermore, it is indicated that the link between the NH_3 oxidation rate and N_2O generation rate by AOB, demonstrates that the two variables are exponentially associated. A metabolic model that produces N_2O by chemically degrading HNO might be used to illustrate this exponential association. This shows that N_2O is created when the rate of NH_3 oxidation is raised and that it is almost certainly created by the unstable decomposition of HNO while NH_2OH oxidation (Law et al., 2012a, p. 3414).

The biological reduction of NO produced during NH_2OH oxidation may also be a source of N_2O besides the chemical breakdown of unstable HNO . For the transmission of electrons

during NH_2OH degradation to the electron transport chain, two molecules of cytochrome *c* (*c554* and *c_M552*) are expressed in AOB (Arp et al., 2007, p. 511). *c554* is proposed to convert NO produced by the enzyme HAO into N_2O and plays a role as a NO reductase *in vitro* (Stein, 2011, p. 139). Moreover, it is suggested that NO reductase or other homologous NO reductases, such as NorS, further decrease the NO generated to N_2O (Law et al., 2012a, p. 3410).

In addition, the dinitrogen tetroxide (N_2O_4)-dependent NH_3 oxidation pathway has been proposed as an alternative to aerobic NH_3 oxidation by AOB. N_2O_4 reduction is accompanied by NH_3 oxidation to NH_2OH , which is catalyzed by AMO. Per mole of N_2O_4 decreased, the cell produces and releases two moles of NO (Schmidt et al., 1998, p. 276). Similar to this, HAO also catalyzes the oxidation of NH_2OH , which produces N_2 as a byproduct and uses NO_2^- as an electron acceptor (Schmidt, 2008, p. 124). It is hypothesized that molecular oxygen indirectly contributes to aerobic processes by re-oxidizing the NO to produce N_2O_4 . The NOx cycle is the name for this NO to $\text{N}_2\text{O}_4/\text{NO}_2^-$ conversion. It is hypothesized that nitrifier denitrification occurring in an aerobic environment contributes to the supply of NO for the NOx cycle (Law et al., 2012b, p. 1270 & 1271).

The N_2O emission during NH_2OH oxidation was examined by experiments. To demonstrate that NH_2OH does not release N_2O by a chemical reaction, control studies under nitrifying circumstances were carried out. While only a minor amount of N_2O was released when NH_2OH was incubated with inactivated sludge, significant amounts of N_2O were released when activated sludge was incubated with aeration and NH_2OH . In addition, when NH_2OH was oxidized, the rate of N_2O emission was substantially higher than when NH_4^+ was oxidized. The explanation for this phenomenon is as mentioned: the reaction of HAO to oxidize NH_2OH to NO_2^- releases four electrons. However, when NH_4^+ is used as the nitrification substrate, a pair of these electrons is used up in the oxidation of NH_4^+ to NH_2OH by AMO. As a result, denitrification can only use one pair of electrons. However, when using NH_2OH as the nitrification substrate instead of NH_4^+ , all four electrons are available for respiration. This is why the NH_2OH oxidation produced significantly more N_2O emissions (Kim et al., 2010, p. 3960).

In addition, N_2O is generated through a direct enzymatic pathway catalyzed by cytochrome P460 from NH_2OH . Originally derived from *N. europaea*, P460 is a constitutively expressed, soluble, periplasmic metalloenzyme. Under aerobic conditions with the existence of oxidant

phenazine methosulfate (PMS) cytochrome P460 interacts with NH_2OH to produce NO_2^- . However, according to the maximum stoichiometry and Gas chromatography (GC) analysis, only 0.7 mole of NO_2^- is formed per mole of NH_2OH and the residual NH_2OH is transformed to N_2O , respectively. On the other hand, under anaerobic conditions, when cytochrome P460 is incubated with NH_2OH , NO_2^- is not produced. A GC analysis demonstrates that cytochrome P460 solely catalyzes the production of N_2O from NH_2OH with the involvement of an oxidant such as PMS or $[\text{Ru}(\text{NH}_3)_6]\text{Cl}_3$. In case an oxidant or an enzyme is absent only traces of N_2O are produced (Caranto et al., 2016, p. 1 & 2).

2.1.3. Heterotrophic denitrification

The process of denitrification involves reducing NO_3^- and NO_2^- in order to get NO , N_2O , and N_2 respectively (Ni and Yuan 2015). Nitrate reductase, nitrite reductase, nitric oxide reductase, and nitrous oxide reductase are the four enzymes involved. Fig. 3 depicts a schematic of the denitrification metabolism. Electron competition between the four parallel denitrification stages may also have an impact on one another, accumulating numerous intermediates, including N_2O . When the rate of electron supply from carbon oxidation is insufficient to fulfill the combined demand for electrons by the four phases of denitrification, there may be competition for electrons between the four steps of denitrification (Ni et al., 2015, p. 338).

Heterotrophic denitrification is dependent on the presence of NO_3^- and organic carbon as well as the levels of oxygen. Especially, the denitrification enzyme turning N_2O into N_2 , nitrous oxide reductase, can be inhibited by oxygen. Due to incomplete denitrification, N_2O rather than N_2 is produced as the final product. Therefore, depending on aerobic or anoxic conditions, dissolved oxygen (DO) is a crucial factor in determining the metabolic pathways that cause N_2O production from either nitrifying or denitrifying microbes (Rassamee et al., 2011, p. 2044). This is especially significant when transitory DO levels are common, which facilitates the coexistence of anoxic and aerobic environments (Aboobakar et al., 2013, p. 525).

N_2O is known as an intermediate substance in heterotrophic denitrification. The maximum rate of N_2O oxidation is nearly four times quicker than the rates of NO_3^- and NO_2^- oxidation (Wicht, 1996, p. 101). This suggests that N_2O could be totally decreased in anoxic/anaerobic environments without any accumulation or release of the gas (Law et al., 2012b, p. 1271). However, it has been discovered that alterations in the environment can cause the N_2OR to be inhibited and cause an accumulation of N_2O . The induction of N_2O reductase appears to fall

behind the others in the majority of cases, which causes an accumulation of N_2O (Holtan-Hartwig et al., 2000, p. 833). Due to the absence of active aeration in the anoxic zones, it has been discovered that the accumulation of N_2O does not result in large emissions of N_2O . Given that N_2O has a relatively high solubility, under these circumstances, the air-liquid contact is constrained to the reactor's surface area, which would result in limited N_2O emission. The accumulated N_2O that is transported into the aerobic zone will be immediately removed (Kampschreur et al., 2009, p. 4098). Therefore, by allowing enough retention time in anoxic zone for the momentarily stored N_2O to be eliminated, emission can be reduced (Vasilaki et al., 2019, p. 405).

In short, aerobic oxidation of ammonia results in the production of NO_2^- and NO_3^- . First, the enzymes AMO and HAO oxidized ammonia to nitrite NO_2^- , and then the enzyme nitrite oxidase oxidized NO_2^- to NO_3^- . N_2O is produced via incomplete NH_2OH oxidation as well as nitrifier denitrification. Under typical aerated circumstances, AOB converts NH_3 into NO_2^- and produces an intermediate product called NH_2OH . However, under adverse circumstances, HAO also goes through a two-step catalysis process that entails changing NH_2OH into an HNO rather than a NO_2^- . This HNO is then polymerized and hydrolyzed, which results in the formation of N_2O . Moreover, under anaerobic conditions, cytochrome P460 produced N_2O directly from NH_2OH . AOB as well as NirK and NorB enzymes involve in the nitrifier denitrification process, converting NO_2^- to NO and then N_2O under limited DO conditions. Whereas, N_2O is the intermediate of heterotrophic denitrification, which is one of the components of the reactions from NO_3^- to N_2 with the enzymes NAR, NIR, NOR, and N_2OR .

2.2. Dominant process

It could be said that nitrifier denitrification, hydroxylamine oxidation, and heterotrophic denitrification have been identified as the three main pathways that emit N_2O in biological wastewater treatment. AOB primarily catalyze the nitrifier denitrification pathway while the role of AOA to N_2O emissions in wastewater is anticipated to be small. AOB convert NO_2^- to NO and then NO to N_2O , catalyzed by NirK and NorB, respectively especially when oxygen is limited. Besides, N_2O can also be the primary by-product of anaerobic NH_2OH oxidation catalyzed by cytochrome P460 in *N. europaea* or generated directly during NH_2OH oxidation catalyzed by the NH_2OH oxidoreductase - HAO enzyme in aerobic conditions. Moreover, the heterotrophic denitrifiers are in charge of turning NO_3^- and NO_2^- into N_2 during denitrification.

NO is converted to N₂O with the help of the catalyst NO reductase. The final phase of denitrification, which is mediated by N₂O reductase, reduces N₂O to N₂ if the denitrification process is left undisturbed. As a result, the heterotrophic denitrification process can produce or consume N₂O (Vasilaki et al., 2019, p. 394).

At a full-scale municipal WWTP, heterotrophic denitrification was found to be a sink of N₂O. In a long-term N₂O monitoring campaign, it was discovered that if COD is sufficient for denitrification, a denitrifying biofilter is capable of consuming a significant amount of dissolved N₂O from the upstream nitrification stage. In the denitrification process, four enzymes are involved. Some heterotrophic bacteria do not have a system for making N₂OR, hence the ultimate product of the denitrification stage is N₂O. Changes in external conditions (DO, NO₂⁻ concentration, pH, carbon limitation, carbon source, and H₂S) (Sabba et al., 2018, p. 9819) can inactivate N₂OR in heterotrophic bacteria, resulting in the denitrification process only reaching the third stage of N₂O production (Lv et al., 2019, p. 1).

The dominant pathway for the production and emission of N₂O could be determined to be nitrification (Valkova et al., 2021, p. 4). Due to the very high gas mass transfer coefficient (k_{La}), aerated phases are where gaseous N₂O emits to the atmosphere happens most frequently. For quiescent zones such as anaerobic zones, anoxic zones, primary settling tanks, and secondary settling tanks, Foley et al. (2010) estimated k_{La} values of 3–4 d⁻¹, which were considerably lower than those estimated for aerated zones (Foley et al., 2010, p. 837 & 839). Based on this data, the total gaseous N₂O emissions from the WWTPs were calculated without taking into account gaseous N₂O emissions from non-aerated phases (Valkova et al., 2021, p. 2). Similarly, according to the the results in full-scale AS system tested by Tumendelger et al. (2014), high DO (2.5 mg/L) favored the hydroxylamine oxidation pathway for the N₂O generation and the N₂O emission factor was 0.14% of the influent NH₄⁺. While the nitrifier denitrification pathway was predominant in producing N₂O when DO was lower (1.5-2 mg/L), and the N₂O emission factor was decreased to 0.03% of the influent NH₄⁺ (Tumendelger et al., 2014, p. 1890). In addition, N₂O was shown to be released in both phases of the investigation in a full-scale activated sludge (AS) WWTP with sequential aerated and non-aerated stages. However, N₂O was stripped from the liquid phase and released into the environment during the aeration, so the emission was considerably higher (0.1% of the influent total nitrogen load) (Mello et al., 2013, p. 16). Moreover, even during the anoxic phase, N₂O substantially

accumulated in the full-scale nitrification reactor and led to elevated emissions at the beginning of the aeration phase (Kampschreur et al., 2008, p. 823).

Under aerobic conditions, N₂O is mostly produced via the NH₂OH oxidation pathway, with relatively modest rates (Sabba et al., 2018, p. 9817). On the other hand, the nitrifier denitrification route becomes increasingly significant as DO concentrations fall, high NO₂⁻ levels are present, and probable nitrogen overload of the system, which increases the rate of N₂O generation. Due to the absence of DO for NH₄⁺ oxidation, N₂O emissions are minimal under fully anoxic conditions (Massara et al., 2017, p. 110). However, it is not always easy to determine which of the two pathways: NH₂OH oxidation or nitrifier denitrification is predominant. Peng et al (2015) indicated that for a wide range of DO and NO₂⁻ levels, nitrifier denitrification prevailed; however, the NH₂OH oxidation route was only effective when both high DO (3.5 mg/L) and low NO₂⁻ concentrations (< 10 mg N/L) (Peng et al., 2015, p. 35).

The predominant N₂O pathways have been summarized and reported for various wastewater treatment procedures according to the methodologies used in the monitoring campaigns such as modified operation mode, mechanistic models, isotopic analysis, and molecular biology. In the majority of anarobic/anoxic/oxic (AA/O) and anoxic/oxic (A/O) process groups, NH₂OH oxidation has not been regarded as the dominating N₂O pathway. In contrast, the NH₂OH oxidation and nitrifier denitrification processes contributed nearly equally to the N₂O generation at the start of the aerobic tank, according to the isotopic analysis in an AA/O setup (Vasilaki et al., 2019, p. 400). The predominant N₂O generation pathway was identified, as shown in table 1. The most contributive pathway was found to be depended on the operational conditions and processes applied in each case.

Table 1. The predominant N₂O generation pathways

Process	Nitrifier denitrification	NH ₂ OH oxidation	Heterotrophic denitrification	Source
AA/O	N ₂ O production increase due to NO ₂ ⁻ concentrations increase (0.22 - 0.51 mg/L) and DO restriction	-	-	(J. Wang et al., 2011)

	(< 2 mg/L)			
AA/O	The main pathway during the second half of the process	Nearly equal amounts of NH ₂ OH oxidation and nitrifier denitrification are responsible for the N ₂ O generation at the beginning of aerobic tank. In the secondary settling tank, NH ₂ OH oxidation consistently outperforms nitrifier denitrification.	-	(Toyoda et al., 2011)
Surface aerator in oxidation ditch (OD)	-	The predominant pathway	-	(Ni et al., 2013)
PN/A granular sludge	-	Main pathway due to the change in aeration patterns	Relatively important contributor	(Castro-Barros et al., 2015)
A/O plug-flow reactor	Dominant with DO lower than 1.5 mg/L	-	-	(Aboobakar et al., 2013)
Sequencing batch reactor (SBR)	The main pathway (N ₂ O generated significantly during the nitrification with low DO)	-	-	(Sun et al., 2013)

CHAPTER 3: Differences by different boundary conditions.

N₂O emissions in WWTPs are caused by a number of processes, and they vary significantly depending on the nitrogen load, the properties of the influent, and the operating and environmental conditions (Massara et al., 2017, p. 108). In this chapter, the parameters impacting on N₂O emissions, such as initial ammonium, dissolved oxygen, nitrite concentration, carbon source, C:N ratio, transient anoxic-aerobic condition, temperature, pH, and phosphorus concentration are indicated and clarified.

3.1. Initial ammonium

The initial ammonium concentrations were highly related to N₂O emission. Under conditions of high NH₄⁺ concentrations and low DO, nitrifier denitrification is not the favor pathway (Caranto et al., 2016, p. 5). An increase in NH₄⁺ oxidation rates is brought on by the inflow of high NH₄⁺ concentrations, which raises the proportion of NH₂OH (Ni et al., 2014, p. 3921 & 3922). According to studies employing AS with high NH₄⁺ concentrations, it is indicated that the amount of N₂O released rises as an aerobic environment changes to an anoxic environment (Law et al., 2012a, p. 3414). Under all ammonium concentrations, the ammonium reduction rate and the NO_x-N production rate were identical; however, the nitrite production rate increased with increasing ammonium concentrations. The activity of AOB did not change as the initial ammonium concentration was increased; nonetheless, the activity of NOB dropped, which could be related to the stronger competitive ability of AOB for oxygen than NOB. As a result, a large amount of N₂O is emitted (L. Shen et al., 2014, p. 779 & 782).

Chandran et al (2011) gave explanatory arguments for this relation. Excessive initial ammonium loading in an AOB bioreactor causes a greater ammonium oxidation rate and also increases *amo* gene expression, which could lead to NH₂OH accumulation. Therefore, NH₂OH would most likely be oxidized to NO and reduced to N₂O. Notice that nitrifier denitrification is triggered in excess of baseline values under oxygen - sufficient conditions. As a result, the first N₂O synthesis is most likely owing to NH₂OH oxidation and NO reduction. It is also potential that higher NO₂⁻ concentrations could induce nitrifier denitrification to produce N₂O after converting the accumulated NH₂OH or attaining a higher rate of NH₂OH conversion into NO₂⁻. Consequently, both oxidative and reductive NO generation promotes the total synthesis of N₂O under high initial ammonium concentration (Chandran et al., 2011, p. 1834 & 1835).

Studies by Valkova et al (2021) indicated similar results. Because nitrification was limited by the low concentration of NH_4^+ in the tank, the stripped N_2O load was reduced successively as N_2O production decreased. The largest N_2O emissions coincided with daily loading peaks. Moreover, observations at some plants demonstrated that the peaks of N_2O produced and released with the off-gas were correlated to fluctuations in the NH_4^+ concentration in the AS tank. According to the Monod curve association between NH_4^+ concentration and AOB growth rate, more N_2O generation can be attributed to an increase in AOB activity (Valkova et al., 2021, p. 4). Other literature documents showed the linked trend in N_2O production with NH_4^+ turnover in AS. In laboratory investigations with an enhanced AOB culture, a nearly exponential association between the ammonia oxidation rate (AOR) and the N_2O generation rate was discovered (Law et al., 2012a, p. 3413). Fig. 4 demonstrates the relation between N_2O emission and NH_4^+ concentrations, which peaks of N_2O off-gas are in direct proportion to the increased NH_4^+ concentrations. In addition, Ahn et al. (2010) conducted a comprehensive survey at 12 WWTPs in the United States and used multivariate regression data mining to discover that high NH_4^+ concentrations, as well as high NO_2^- and DO concentrations, were positively correlated with N_2O fluxes from aerobic zones of AS tanks (Ahn et al., 2010, p. 4509).



Vietnamese-German University

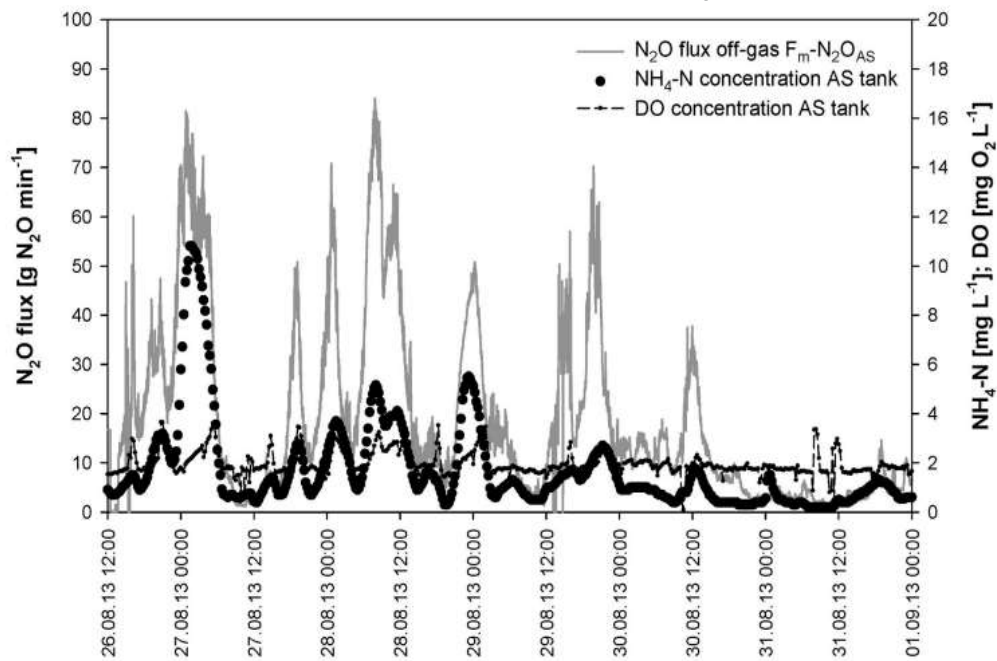

Figure 4. The relationship between N_2O emission and NH_4^+ concentration (Valkova et al., 2021, p. 5).

3.2. Dissolved oxygen (DO) and Nitrite concentration

3.2.1. DO

DO is regarded as a critical factor controlling N₂O emission during nitrification and lower DO concentrations result in larger emissions. Under oxygen-limited conditions, the nitrifier denitrification route primarily increases N₂O emissions. At the same time, NO₂⁻ is used as an electron acceptor by autotrophic ammonia oxidizers to save oxygen for the transformation of ammonia to hydroxylamine. Fig.5 shows the relationship between N₂O fluxes and DO concentrations in aerobic tanks. When DO content was higher than 2 mg/L, the N₂O fluxes were lower than 30 mg/m²h and maintained a fairly constant level. As soon as DO concentration fell below 2 mg/L, the N₂O fluxes significantly increase and reach the highest flux of 65 mg/m²h at a DO concentration of 0.75 mg/L (J. Wang et al., 2011, p. 150). The N₂O emissions from nitrification were predicted to be between 0.1% and 0.4% of the nitrogen load, with an emission peak at DO concentration of 1 mg/L (Tallec et al., 2006, p. 2978 & 2979). On the other hand, during the denitrification process, both denitrification enzyme synthesis and activity are inhibited by oxygen, especially N₂OR is more sensitive to oxygen than the NIR and NAR. As a result, N₂O is emitted during denitrification when concentration is low (Otte et al., 1996, p. 2424). Furthermore, according to the study by Tumendelger et al. (2014) as mentioned, high DO (2.5 mg/L) promoted the NH₂OH oxidation pathway for the N₂O generation in the full-scale AS system and the N₂O emission factor was 0.14% of the influent NH₄⁺. However, N₂O was mostly produced by the nitrifier denitrification at lower DO (1.5 - 2 mg/L), and the N₂O emission factor was decreased to 0.03% of the influent NH₄⁺ (Tumendelger et al., 2014, p. 1890).

Under low DO concentrations, the nitrifier denitrification is enhanced. It was proven by experiments with the model-based data analysis that by increasing DO concentration from 0.2 to 3 mg/L, the proportion of nitrifier denitrification declined from 95% to 73% while the NH₂OH oxidation rise from 5% to 27% (Peng et al., 2014, p. 17). However, under high DO concentrations, the generation of N₂O through the NH₂OH oxidation pathway is primary. N₂O production under insufficient DO conditions when there is a consistent source of reducing equivalents from NH₄⁺ or NH₂OH oxidation could be especially accelerated by high NO₂⁻ concentrations. A microbial adaptation to restricting oxygen is further indicated by the fact that the amount of N₂O and NO produced under sustained long-term oxygen limitation is less than

that produced during transient anoxic-aerobic disturbances (Chandran et al., 2011, p. 1835). These findings were consistent with the experiments conducted by Ahn et al. (2011) because low DO concentrations and high nitrite concentrations are known to be the drivers for *nirK* and *norB* expression in AOB. Despite persistently high NO_2^- and low DO concentrations, *nirK*, and *norB* quantities decreased to undetectable levels after the initial transiently high values. Therefore, it is likely that the AOB in this study may have adjusted to the persistently high NO_2^- and low DO concentrations, which led to a concurrent stabilization of both emissions and *nirK* and *norB* expression (Ahn et al., 2011, p. 2739).

Nitrification tanks of a WWTP need to be properly controlled due to the significant influence of the DO concentration on N_2O emission. Insufficient DO concentration in the nitrification tank results in local oxygen restriction and accelerates N_2O generation. Meanwhile, excessive aeration rates also increase the oxygen introduced to the denitrification tank, which can promote N_2O emissions (Kampschreur et al., 2009, p. 4098). Therefore, off-gas N_2O monitoring has been suggested as a method of process control to ensure effective air supply and identify process failure (Sivret et al., 2008, p. 116).

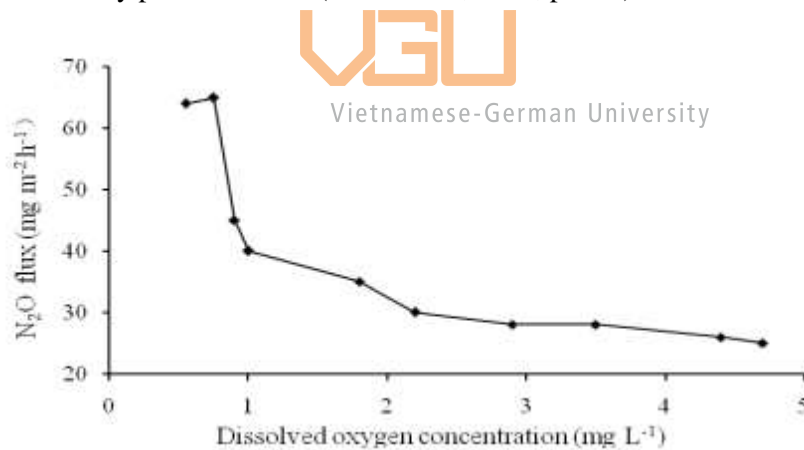

Figure 5. The relationship between N_2O fluxes and DO concentration (J. Wang et al., 2011, p. 150).

3.2.2. Nitrite

NO_2^- has a significant impact on the formation of N_2O in the process of nitrification. Both full-scale and lab-scale investigations have shown that the presence of NO_2^- causes a considerable rise in N_2O production. It is suggested that the concentration of NO_2^- affects the amount of N_2O produced by AOB denitrification (Wunderlin et al., 2012, p. 1031). By increasing the expression of the *nirK* gene, it has been demonstrated that high NO_2^- concentrations stimulate nitrifier denitrification (Beaumont et al., 2004, p. 149). Additionally, in an *N. europaea* batch

culture with high NO_2^- concentrations (280 mg N/L), the exponential phase transcription of *nirK* and *norB* rises significantly (Yu et al., 2010a, p. 6). Nevertheless, with higher NO_2^- concentrations (above 50 mg N/L) the ability of AOB to produce N_2O is limited in a nitrification system (Law et al., 2013, p. 14). Additionally, when the NO_2^- concentration was beyond 500 mg N/L, further data analysis using a mathematical model showed that the NH_2OH oxidation pathway became dominant (Law et al., 2012a, p. 3415).

Fig. 6 illustrates the N_2O emission rate in two cases of four DO levels: with and without NO_2^- addition. The black column represents “without NO_2^- addition”, while the white and grey ones describe “with NO_2^- addition”: the white one is the N_2O emission rate from nitrifying activated sludge by nitrifier denitrification, and the grey one is the N_2O emission rate from denitrification. The proportion of nitrite added always markedly increases the amount of N_2O emission, increasing it by four times at 0.1 and 2 mg O_2/L , six times at 0.6 mg O_2/L , and even eight times at 1 mg O_2/L . The main process thought to be behind the N_2O emission peak at 1 mg O_2/L is nitrifier denitrification. On the other hand, a nitrite addition stimulates N_2O emissions from nitrifier denitrification, this stimulation is strongest at 1 mg O_2/L and weaker both below and above this value (Tallec et al., 2006, p. 2978).

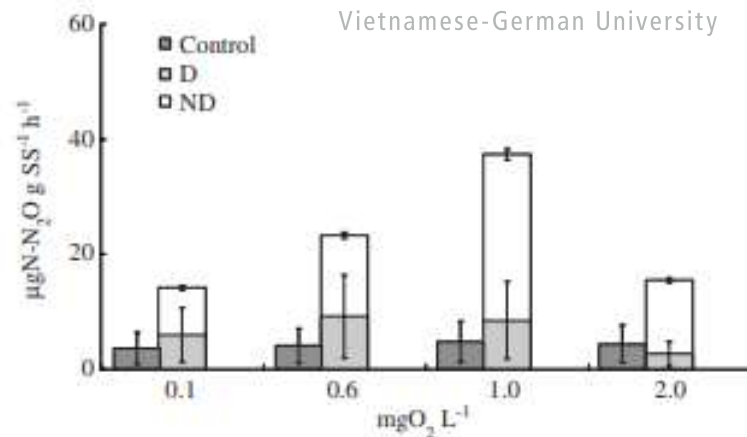

Figure 6. N_2O emission rate in two cases of four DO levels: with and without nitrite addition (Tallec et al., 2006, p. 2978).

3.2.3. DO and Nitrite combination effect

There have been many previous studies showing the correlation between nitrite, DO and N_2O , but very few studies combine both nitrite and DO factors. In addition to having an indirect impact on N_2O production through the NH_2OH oxidation route, it is anticipated that DO also

have an impact on the nitrite reduction by AOB by affecting the electron fluxes. DO and nitrite concentrations shift simultaneously, they typically do not vary separately. In fact, fluctuations in DO cause the alteration of nitrite concentration because during nitrification, AOB convert ammonia to nitrite; the amount of accumulation of nitrite depends on the DO content. The two components were not separately altered in these situations, it is difficult to distinguish between the effects of DO and nitrite (Peng et al., 2015, p. 30).

Peng et al. (2015) conducted experiments in an enriched nitrifying sludge at different concentrations of nitrite (3 - 50 mg N/L) and DO (0.35 - 3.5 mg O₂/L). Results showed that at distinct concentrations of DO and NO₂⁻, the N₂O production pathways of AOB shifted, as a result of the combined influence of DO and NO₂⁻. N₂O production rate at relatively low DO levels (0.35 - 1.5 mg O₂/L) was more dependent on NO₂⁻ concentration than it was at higher DO levels (2.5 and 3.5 mg O₂/L) (Fig.7). In addition, it is indicated that when NO₂⁻ concentration increased, the contribution of nitrifier denitrification pathway to N₂O production increased, but when DO concentration increased, the contribution of the AOB pathway to N₂O production dropped. Fig.8 showed that the AOB denitrification pathway predominated in most of the situations, while the NH₂OH oxidation pathway predominated at high DO (3.5 mg O₂/L) and low NO₂⁻ levels (< 10 mg N/L). It could be said that any wastewater treatment method could benefit significantly from the knowledge gained about the joint impacts of DO and nitrite on N₂O generation by AOB. For example, in a PN/A process, DO should be maintained at a relatively high level (DO > 1.5 mg O₂/L) to reduce NO₂⁻ accumulation and N₂O production by AOB in such a nitrification reactor. However, in a traditional nitrogen removal process by nitrification and denitrification, it is crucial that nitrite accumulation be avoided or minimized. This study suggests that DO should likewise be kept at a high level (DO > 1.5 mg O₂/L) (Peng et al., 2015, pp. 33 - 35).

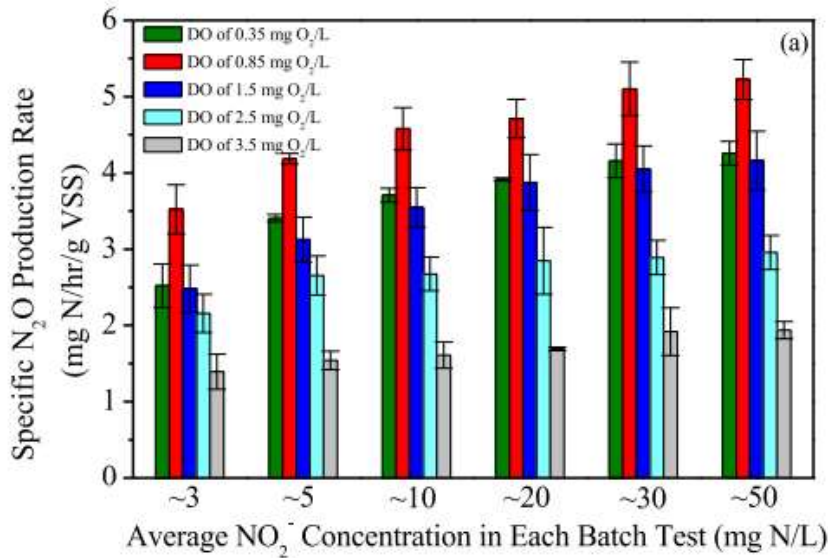

Figure 7. The dependence of N₂O production on DO and nitrite concentrations (Peng et al., 2015, p. 32)

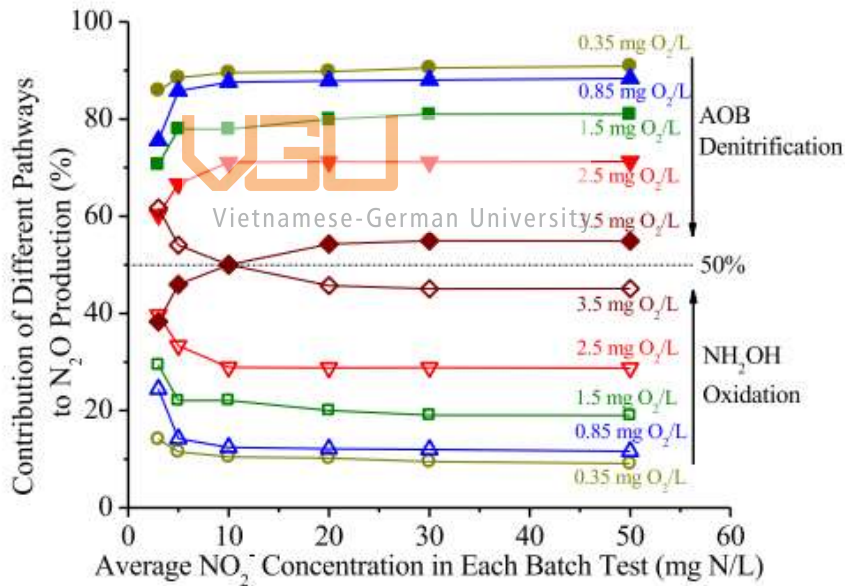

Figure 8. The contributions of N₂O production pathways under different DO and nitrite concentrations (Peng et al., 2015, p. 35).

3.3. Carbon sources

The presence and composition of the C-sources potentially impact the N₂O generation. In an anaerobic-aerobic lab-scale process, the influences of two different C-sources, sludge fermentation liquid, and acetic acid, were evaluated. It is reported that N₂O emissions were reduced by 68.7% when sludge fermentation liquid was employed instead of acetic acid as C-

source. The activities of denitrifying enzymes were impacted by the presence of Cu^{2+} and propionic acid in the sludge fermentation liquid, which led to a decline in the NIR/NOR and NOR/ N_2OR ratios of activity. Therefore, during the denitrification process, less NO and N_2O were produced (Zhu et al., 2011, p. 2137). These enzymes need electron donors, which are primarily found in organic carbon. As a result, because it influences denitrification kinetics, the carbon source used for denitrification is important for reducing N_2O (Ray et al., 2014, p. 291). A possible connection between N_2O reduction activity and the *nosZ* gene, which encodes the catalytic subunit of the N_2OR , has been identified. When sludge alkaline fermentation liquid was used as the carbon source instead of acetic acid in the anoxic-aerobic biological wastewater treatment method, greater *nosZ* community abundance was noted (Zhu et al., 2011, p. 2141), which indicated the higher ability to convert N_2O to N_2 . Besides, in order to examine the impact of 3 various carbon sources (glucose, sodium acetate, and soluble starch) on the N_2O emission, Hu et al. (2013) developed 3 lab-scale anoxic/aerobic sequencing batch reactors. The percentage of the eliminated total nitrogen (TN) that is transformed to N_2O , or the N_2O conversion ratio of soluble starch, glucose, and sodium acetate, were 2.8%, 5.3%, and 8.8% respectively. According to the microbiological analysis, it was explained that the sodium acetate-containing SBR had much less variety among denitrifiers, which made it easier for N_2O to be released via the heterotrophic denitrification pathway. These results indicated that the community of denitrifiers, as well as N_2O emission during the anoxic phase, are significantly influenced by the carbon source (Hu et al., 2013, p. 1059 & 1068). In addition, a comparison of a lab-scale anoxic/aerobic AS system fed with methanol and sodium acetate showed decreased N_2O emissions in the sodium acetate condition. The process fed with methanol had an N_2O emission factor of 2.3% while the process fed with sodium acetate had an N_2O emission rate of 1.3%, which revealed that the biomass increased in the number of bacteria and the ability to reduce N_2O with sodium acetate as the carbon source (Song et al., 2015, p. 2375 & 2379). Besides, in comparison of acetate and polyhydroxybutyrate (PHB), N_2O emission with acetate was much less than that with PHB as the electron donor during the anoxic phase (L. Shen et al., 2014, p. 781). Furthermore, it is demonstrated that mannitol increased the completion of heterotrophic denitrification by reducing the N_2OR enzyme inhibition brought on by the high NO_2^- concentration in the partial nitrification system. Indeed, the impact of utilizing mannitol rather than sodium acetate as the innovative carbon source was assessed a lab-scale partial nitrification SBR system. Mannitol and sodium acetate both converted to N_2O at rates of 21.24% and 41.02%, respectively (Zhang et al., 2016, p. 793). It has been suggested that

mannitol can efficiently eliminate reactive oxygen species, reduce the activity of antioxidant enzymes, (B. Shen et al., 1997, p. 531), and shield microorganisms from harm caused by high nitrite concentrations (Zhang et al., 2016, p. 794).

The effects of different C:N ratios were also indicated. According to a pure culture of *A. faecalis* study, when carbon supplies are restricted, N₂O production rises by 32–64% but N₂ production falls noticeably (Schalk-Otte et al., 2000, p. 2080). Indeed, the different denitrification enzymes compete for electrons when carbon sources are insufficient, which could lead to inadequate denitrification. The NAR and NIR have a considerably larger affinity for electrons than the NOR and N₂OR, so N₂O and NO are anticipated to accumulate during carbon-limited denitrification (Law et al., 2012b, p. 1272 & 1273). In contrast, N₂O production was rapidly reduced when extra carbon was added to eliminate electron competition. Particularly, under the C:N ratio of 0.75, PHB showed significantly less denitrification than acetate as the electron donor but the amount of N₂O emission is 0.75 mg/L and less than 0.008 mg/L, respectively. Similarly, when acetate acted as the electron donor under the C:N ratio of 1.5, N₂O emission was also minimal (less than 0.007 mg/L), while PHB served as the electron donor, the N₂O emission increased to 0.05 mg/L (L. Shen et al., 2014, p. 778). When the C:N ratio was less than 3.5 in a laboratory scale intermittently aerated reactor, 20–30% of influent N was released as N₂O (Itokawa et al., 2001, p. 657). A C:N ratio greater than 4 is necessary for full denitrification. Nevertheless, different metabolic pathways use various carbon sources, so this may not apply to all kinds of carbon sources (Law et al., 2012b, p. 1272 & 1273).

3.4. Transient anoxic–aerobic conditions

In a wastewater treatment system, in order to ensure nitrification and denitrification separately and completely, anoxic and aerobic periods are designed. However, recirculating the activated sludge between anoxic and aerobic periods would lead to the frequently varying environmental conditions of the mixed bacterial community. There may be variations within a compartment; for instance, the reduction of DO concentration due to an increased influent rate or a restriction on the aeration capacity (Law et al., 2012b, p. 1271). Additionally, NO₂⁻ recycling back into the anoxic zone is enhanced by NO₂⁻ accumulation in the aeration tank. It is hypothesized that NO₂⁻ serves as the limiting substrate for AOB oxidation in the anoxic zone, so a temporary rise in the NO₂⁻ concentration recycled from the aeration tank may cause AOB to produce more

N₂O in the anoxic zone (Foley et al., 2010, p. 841). Therefore, it also has been demonstrated that the immediate increase in N₂O production is caused by the transient changes in DO concentration, particularly from AOB (Yu et al., 2010b, p. 1313).

N₂O generation from AOB is caused by the recovery from an anoxic tank rather than the shifts into an anoxic condition. While NO accumulated under anoxic circumstances in a pure culture of *N. europaea*, N₂O was only formed during the transition from anoxic to aerobic conditions (Yu et al., 2010b, p. 1313). The accumulation of NH₄⁺ during anoxia and the oxygen concentration after recovery were both linked with the N₂O generation during the recovery period. Additionally, there was no correlation between changes in the amount of gene expression and the increased N₂O generation during the recovery phase. Thus, it was determined that the propensity of nitrifying cultures to create N₂O is caused by a sudden change from anoxic to aerobic conditions because it takes time for the metabolism of bacteria to adapt to changes in their environment, which causes significant peak N₂O emissions. After the change from an aerobic to an anaerobic environment, the synthesis of N₂OR has a longer lag phase than the synthesis of NOR. Additionally, after the change from anaerobic to aerobic conditions, N₂OR activity ceases instantly but NOR activity continues at a reduced rate for a few hours (Law et al., 2012b, p. 1272) because denitrifying enzymes are inhibited by O₂ in both their production and their function, particularly the N₂OR (Otte et al., 1996, p. 2421).

3.5. Temperature and pH

In a batch reactor that was fed with a synthetic solution including acetate, NO₃⁻, and AS, the effect of temperature on N₂O emissions during denitrification has been demonstrated. The findings showed that N₂O production increased as temperature decreased: at 20°C, 10°C, and 5°C, respectively, N₂O emissions climbed from 13% to 40% and then to 82% of the total denitrified nitrogen. Low temperatures slowed down the activity of all denitrification enzymes, especially N₂OR, which is inhibited at 10°C and 5°C, leading to an accumulation of N₂O in the reactor (Adouani et al., 2015, p. 21).

Experiments on mixed liquor to see how rising temperatures might affect the amount of N₂O that accumulated during denitrification have been conducted. The particular N₂O reduction rates increased by 41% when the temperature climbed from 25°C to 35°C. However, stripping intensified around 35°C because the solubility of N₂O in the liquor decreased. N₂O is 30% less soluble in mixed liquor at 35°C than it is at 25°C (Fig. 9). The decreased N₂O solubility at

higher temperatures was mirrored in the higher Henry's constant at 35°C. The simulation findings showed that at 35°C, the reduced solubility of N₂O could result in a larger mass transfer coefficient. N₂O transfer velocity between the liquid and gas phases was shown by the mass transfer coefficient. At higher temperatures, it is anticipated that N₂O exchange between the air and mixed liquor will happen more quickly and be more responsive to variations in the concentration of dissolved and gaseous N₂O. Additionally, after soluble N₂O was reduced by microbes, lower solubility prevented N₂O from resolving back into the liquid phase. The net N₂O transfer rate took longer to reach equilibrium at 35°C (Poh et al., 2015, p. 9224 & 9225). As a result, even while greater temperatures are used to improve the denitrification kinetics, they are likely to result in increased emissions in the long run (Massara et al., 2017, p. 116).

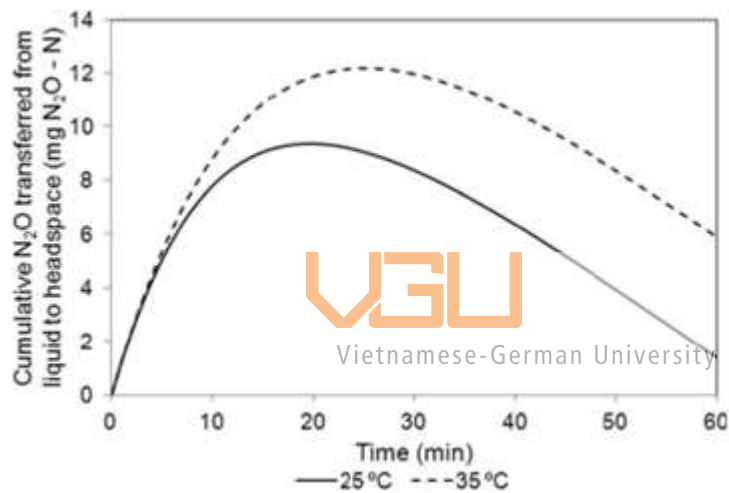

Figure 9. The effects of temperature on the stripping of N₂O (Poh et al., 2015, p. 9223).

The substrate speciation, enzymatic processes, stability of the bacterial cell wall, AOB and NOB kinetics are all significantly impacted by pH (Vangsgaard et al., 2013, p. 2609). The enzyme nitrous oxide reductase, which regulates the conversion of N₂O to N₂, is very sensitive to pH. Along with biological mechanisms, pH also affects abiotic production and stripping effects (Kanders et al., 2019, p. 1617).

The N₂O production in a partial nitritation SBR treating sludge reject water with an enhanced AOB culture was examined under a pH range of 6.0 to 8.5. The pH range between 6.0 and 7.0 showed the lowest N₂O generation (0.15 ± 0.01 mg N₂O-N/h/g VSS), whereas pH = 8.0 showed the highest (0.53 ± 0.04 mg N₂O-N/h/g VSS). When pH was raised to pH 8.5, there was a reduction in the rate of N₂O generation (Fig. 10). The linear correlation between the AOR and the rate of N₂O formation shows that the pH effect may only be felt indirectly by increasing

ammonium oxidation activity, AOR increased as pH rose from 6.0 ~ 7.0 to 7.5 ~ 8.0 but reduced when pH rose to 8.5 (Fig. 11a). Besides, Fig. 11b demonstrates that within the pH range of 6.0 - 8.5, there is a linear association between the specific ammonium oxidation rate and the average N₂O production rate, which means that the pH caused a change in the AOR, which may have then had an impact on the rate at which N₂O was produced. Indeed, higher AOR results in a higher rate of electron generation and more electrons were redirected to the pathway leading to nitrifier denitrification (Law et al., 2011, p. 5938 & 5942). This would result in more N₂O being produced because AOB probably cannot convert N₂O to N₂ (Poth et al., 1985, p. 1136). An alternate possibility is that a greater AOR would cause a higher concentration of the chemical intermediates involved in the conversion of ammonium to nitrite, such as NH₂OH and NOH, then they were broken down faster and N₂O was produced (Law et al., 2011, p. 5942). Similar patterns were seen in pure culture research utilizing *N. europaeae*, where N₂O production peaked at pH 8.5 and decreased as pH increased further, while N₂O production was lowest at pH 6.0 (Hynes et al., 1984, p. 1402). Li et al. (2015) looked into the impact of pH on the accumulation of N₂O in a domestic-municipal SBR. pH became the only variable component in the process at a steady DO (3 mg/L). The accumulation of N₂O increases with rising pH, indicating that the pH range of 6.0-8.5 had an impact on the accumulation of N₂O (Li et al., 2015, p. 7). However, the pH in WWTPs is typically between 7 and 8 and stable, the pH effect is only anticipated to have a minimal impact (Kampschreur et al., 2009, p. 4100).

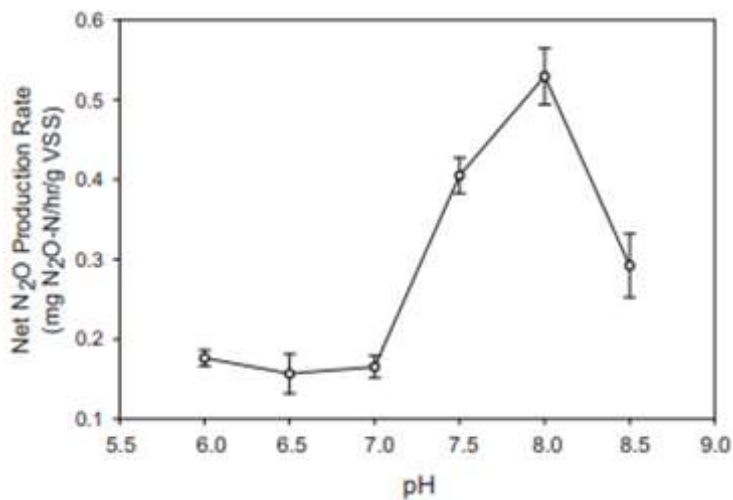

Figure 10. The effects of various pH on N₂O production rate (Law et al., 2011, p. 5939).

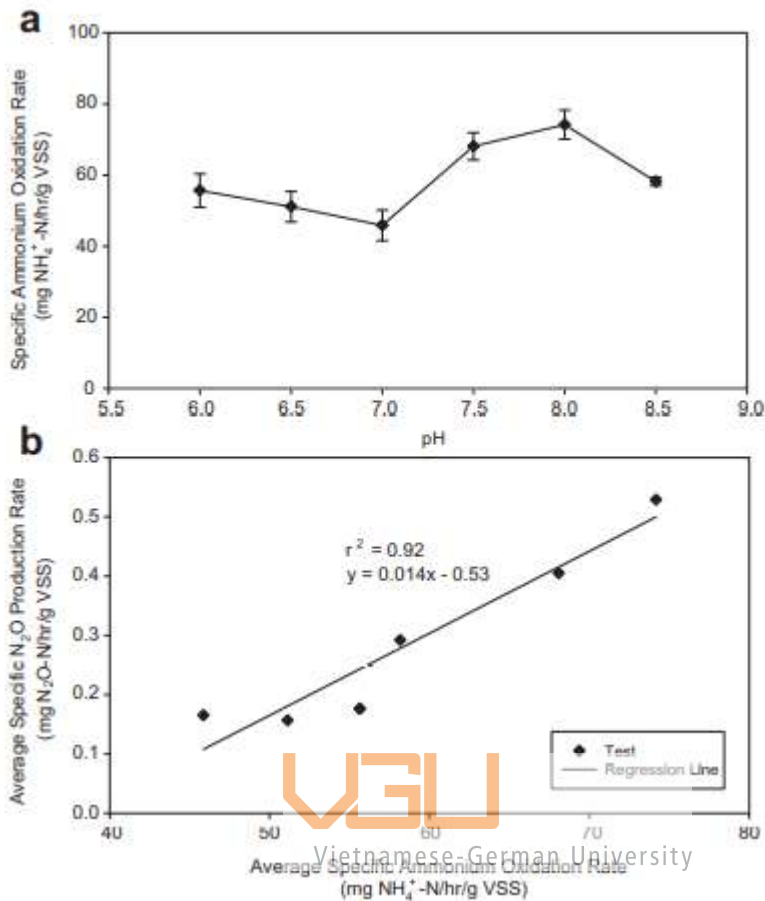

Figure 11. The effects of pH on the AOR (a) and The relationship between AOR and N₂O production rate (b) (Law et al., 2011, p. 5940).

In order to mitigate N₂O emission, temperature and pH should be controlled. However, an unrestricted increase in pH and temperature could ultimately have a negative impact. For instance, a pH increase above 7 is expected to result in a greater AOR and a buildup of N₂O via the AOB pathways. The N₂O produced during denitrification also becomes less soluble at temperatures over 25°C, which facilitates its conversion to gas. Overall, the conditions that guarantee the end of nitrification are a pH controlled at around 7 and a temperature of about 20°C (Massara et al., 2017, p. 116).

3.6. Phosphorus concentration

The concentration of phosphorus has a substantial impact on the denitrification rate. Wang et al. (2020) conducted experiments to indicate phosphorus effects on N₂O production using denitrifying phosphorus removal (DPR), a revolutionary BNR technique and emerging as an

alluring replacement for traditional BNR. A high abundance of denitrifying phosphorus accumulating organisms (DPAOs) was found at high phosphorus concentrations, which is conducive to denitrification. However, a poor rate of denitrification resulted from a low abundance of denitrifiers when the phosphorus concentration was low (0.5 mg/L). Additionally, glycogen accumulating organisms (GAOs) accounted for the majority of the denitrifiers at low phosphorus concentrations, but DPAOs had a higher denitrification capability than GAOs and could use nitrite more readily than GAOs (Ribera-Guardia et al., 2016, p. 106). In the anaerobic phase, glycolysis and polyphosphate hydrolysis produce the energy needed for DPAOs to store poly- β -hydroxyalkanoates (PHAs), significant substances that impact on denitrification efficiency. Compared to the polyphosphate metabolism used by PAOs, the glycogen metabolism used by GAOs is far more complex and less effective in producing energy. Therefore, it could be said that higher phosphorus concentrations lead to efficient denitrification. It is also revealed that a high COD:P ratio tended to encourage the growth of GAOs rather than DPAOs, whereas a low COD:P ratio was beneficial to the enrichment of DPAOs (Mino et al., 1998, p. 3202). As a result, when the same concentration external carbon source is supplied, GAOs store less PHAs than DPAOs and the performance of denitrification would be decreased. Furthermore, NO, a cytotoxin that severely inhibits the elimination of pollutants because it is hazardous to the metabolism of microorganisms is detected to be accumulated with a low phosphorus concentration of 0.5 mg/L. Therefore, the rate nitrite-denitrifying phosphorus removal (N-DPR), a significant source of N₂O production, deeply connected linked to excessive NO and N₂O accumulation. Moreover, the COD:N:P ratio, which is necessary for microorganism development, should be 100:5:1. When the phosphorus content was 0.5 mg/L, compared to the ideal organics to nutrition ratio, the phosphorus concentration was clearly insufficient (S. Wang et al., 2020, p. 45933).

Batch tests examined the percentage of N₂O accumulation with DPAOs and GAOs cultures. In batch reactors with no head-space to have N₂O stripping, 7 distinct batch tests with various combinations of electron acceptors such as NO₃⁻, NO₂⁻, and N₂O were conducted. The results indicated that in comparison to DPAOs, GAOs showed greater N₂O accumulation per N-reduced (table 2). For the test where only NO₂ was utilized (test B), the accumulation percentage was very high - around 83%. The highest N₂O accumulation level found in DPAOs (31% for test F) was generally lower than that found in GAOs. These numbers suggest that significant N₂O emissions are very likely to occur in systems where GAOs perform

denitrification and/or where nitrite builds up. In all of the conditions examined, GAOs had lower nitrous oxide reduction rates than DPAOs. As a result, the GAO culture had greater N₂O accumulation (Ribera-Guardia et al., 2016, p. 107 & 111).

Table 2. The proportion of N₂O accumulation per N-reduced (Ribera-Guardia et al., 2016, p. 111).

Type of batch test	N ₂ O accumulation per N-reduced (%)	
	DPAOs	GAOs
A	8.72 ± 0.2%	7.12 ± 2.16%
B	17.40 ± 5.9%	83.95 ± 4.79%
D	0.00	13.71 ± 5.81%
E	20.11 ± 1.9%	56.90 ± 4.92%
F	31.20 ± 2.7%	45.45 ± 0.89%
G	11.30 ± 3.1%	48.45 ± 5.94%

Batch test C is not present because only N₂O was added.

3.7. Summary of boundary conditions

In a word, the parameters such as initial ammonium, dissolved oxygen, nitrite concentrations, carbon sources, C:N ratios, transient anoxic-aerobic condition, temperature, pH, and phosphorus concentrations impact the N₂O emissions in WWTPs at different levels. In particular, high levels of NH₄⁺ increase the amount of NH₂OH which leads to high N₂O production. The nitrifier denitrification pathway largely enhances N₂O emissions when oxygen is limited, while under high DO concentration, the NH₂OH oxidation pathway is predominant. Similar to DO concentration, nitrite should be controlled to be sufficient; too low or too high nitrite accumulation both result in increased N₂O generation. For the reduction of N₂O, the denitrification carbon sources are crucial, so the choice of different carbon sources (acetate, glucose, methanol, mannitol, etc...) as well as different C:N ratios should also be carefully considered. Additionally, the abrupt transition from anoxic to aerobic conditions and vice versa results in large peak N₂O emissions because it takes time for bacteria to adjust their metabolism to environmental changes. Furthermore, temperature around 20°C and neutral pH are suitable conditions for complete denitrification and avoiding N₂O accumulation. Finally, high phosphorus concentration to adapt to nutrient demand is considered as the indirect influent factor of N₂O formation. However, the low dissolved oxygen concentration in the nitrification stage, elevated nitrite concentrations in both the nitrification and denitrification stages, and a

low C:N ratio in the denitrification stage are the three most crucial operational parameters that cause N₂O emission in WWTPs (Fig. 12). These elements should be the primary focus of operational initiatives to reduce N₂O emissions (Kampschreur et al., 2009, p. 4100). Thereby, the vital elements affect on N₂O emission during nitrification and denitrification stage are DO, nitrite concentration, and C:N ratio.

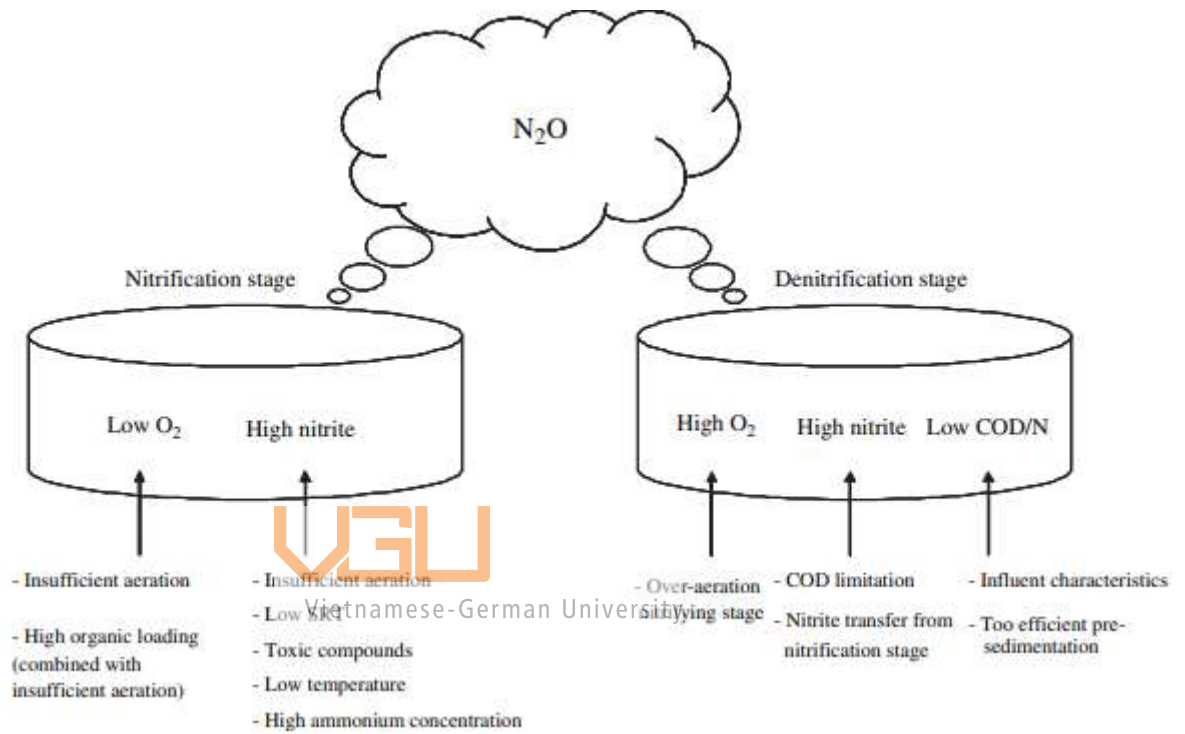

Figure 12. Key parameters resulting in N₂O emissions (Kampschreur et al., 2009, p. 4099).

CHAPTER 4: Differences between various wastewater treatment processes.

Different wastewater treatment processes show different amounts of N₂O emissions. For example, in three different full-scale wastewater treatment processes, an anoxic-oxic A/O process, a SBR, and an OD, it was investigated the quantity of N₂O emissions. The results indicated that effective DO control during nitrification and improved organic carbon usage during denitrification serve as mitigation measures to ensure the successful completion of nitrification-denitrification and reduced NO₂⁻ and N₂O accumulation. In this chapter, the comparison of N₂O emissions between suspended – biofilm systems, nitrification/ denitrification – traditional nitrification/ denitrification, and conventional activated sludge – aerobic granular sludge shall be illustrated and discussed.

4.1. Comparison of N₂O emission from conventional activated sludge (suspended) and biofilm (attached) system.

4.1.1. An overview of suspended and attached growth system.



Vietnamese-German University

The conventional activated sludge (CAS) process is a suspended growth system consisting of a biological tank where organic carbon experiences an aerobic tank for biological degradation, followed by a secondary settling tank to separate sludge from treated water. The CAS system of wastewater treatment is one of the most commonly used to manage a variety of loads that it may be relied upon repeatedly to treat influent and discharge back into the environment. The knowledge that a professional might be able to quickly solve any malfunctions gives them a lot of comfort. However, the bulkiness of CAS systems is one of its most obvious drawbacks, occupying a significant amount of space. Besides, variability exists in the effluent quality that CAS systems produce despite the fact that wastewater treatment can be a time-consuming operation (Frankel, 2022).

The biofilm systems comprise media to carry microorganisms in the basin. Media float through the water and enhance the amount of water surface area microorganisms can develop. As a result, the microorganisms have the chance to come into contact with and decompose more organic material. Biofilm system assists to overcome the disadvantages of CAS systems. Particularly, by utilizing a single tank for the whole procedure as well as enhanced surface area

for microorganisms, it contributes to saving space and a smaller environmental impact. Furthermore, in biofilm systems, it takes just a few hours to complete the wastewater treatment process, less time than CAS systems do. However, there are some disadvantages existing in biofilm systems that should be considered. Continuous monitoring is necessary for biofilm systems to function properly and produce effluent, despite they require little maintenance. (Frankel, 2022).

As mentioned in Chapter 2, N_2O is produced during biological treatment since it is a necessary intermediate in the nitrification and denitrification pathway. Ammonia oxidizing bacteria were found to behave substantially differently in biofilms than they do in suspended growth environments, because of substrate gradients, the formation, and diffusion of NH_2OH , a nitrification intermediary inside the biofilm (Sabba et al., 2015, p. A). In contrast, microorganisms in suspended growth systems are exposed to the same bulk concentrations of intermediates and substrates. N_2O emissions can also be significantly influenced by the biofilm thickness. For instance, in a denitrifying fluidized bed bioreactors (DFBBRs) system, the N_2O emissions would be decreased by increasing the biofilm thickness. Particularly, for biofilm thicknesses of 680 mm and 230 mm, the emissions were 0.53% and 1.57% of the influent TN, respectively. The slow-growing denitrifiers were better retained and N_2O reduction to N_2 was increased with the thicker biofilm (Eldyasti et al., 2014, p. 288 & 289).

4.1.2. The differences of biofilm thickness in nitrifying biofilms and denitrifying biofilms

Kinetics can be used to predict the behavior of denitrifying bacteria in suspended growth environments, but the behavior of denitrifiers in biofilms is less clear. N_2O generated in one area of the biofilm may spread to others and be reduced due to substrate gradients in the biofilm. Modeling can be a helpful approach to better understanding the causes of N_2O emissions. For a range of bulk conditions and biofilm thicknesses, numerical modeling is used to assess N_2O generation in denitrifying biofilms (Sabba et al., 2017b, p. 6). In the outer layer of biofilm, where NO_3^- and NO_2^- concentrations are higher, N_2O is produced as a denitrification intermediate; but, in deeper areas, where NO_3^- and NO_2^- concentrations are lower, N_2O can diffuse and be transformed, similar to the production, diffusion, and consumption of NH_2OH in nitrifying biofilms. Furthermore, in suspended growth systems, NO_3^- would not be denitrified when O_2 is present; however, under these conditions, biofilms generate N_2O because

anoxic zones allow denitrification in the deeper biofilm. In addition, diffusion of NO_2^- from the inner to the outer of the biofilm is another impact and NO_2^- is less sensitive to O_2 inhibition as well as has a greater maximal specific reduction rate than NO_3^- . From these findings, it could be seen that intermediates inside the biofilm can spread to various zones and experience transformations that would not happen in their original surroundings (Sabba et al., 2017b, p. 21 & 22).

Another modeling study investigated both nitrifying and denitrifying biofilms to predict N_2O emission. Models of biofilms with various thicknesses were created. The nitrifying biofilm had a thickness of 2 μm , whereas the denitrifying biofilm had a thickness of 5 μm , both representing for suspended system because of no gradients in the substrate within their depth. According to the biofilm model for AOB, biofilm emissions of N_2O can be much higher than those from suspended-growth systems, resulting from the transfer of hydroxylamine, as mentioned, from the aerobic to anoxic areas of the biofilms. On the other hand, in denitrifying biofilms, COD, NO_2^- concentrations, and biofilm thickness all affect the difference. Generally, biofilms can be distinguished from suspended-growth systems by the accumulation and transport of important intermediates, specifically NH_2OH and NO_2^- . Biofilms have significantly more complicated N_2O emission pathways than suspended-growth systems, and their emissions may even be higher in some situations (Sabba et al., 2017a, p. 1).

In nitrifying biofilms, it is predicted that thicker biofilms emit more N_2O than thin biofilms. Fig. 13 shows that the maximum rate of N_2O production of 50 μm and 100 μm biofilms reaches respectively 0.03 and 0.045 mmol/L.h, while that of 2 μm , which represents suspended growth system, increases slightly and does not exceed 0.0025 mmol/L.h. With an increase in O_2 , the emission rates rose. N_2O reached its maximum at significantly lower O_2 levels for thicker biofilms, which is different behavior from that of suspended growth systems and thinner biofilms. Greater biofilm thicknesses exhibited similar broad trends in N_2O emissions. This pattern demonstrated that N_2O emissions were present throughout a significantly larger range of O_2 levels in thicker biofilms in addition to increased emissions. The primary reason is that NH_2OH formed in the outer regions diffuses to the inner areas of the biofilms and causes the concentration difference because of net consumption in the inside and net generation of NH_2OH in the outside biofilms. Normally, to minimize the emission of N_2O , the rate of NH_3 oxidation and NH_2OH oxidation should be comparable at a steady state. However, in thick biofilms, the outer regions of the biofilm have a high rate of nitrification due to the high

amounts of NH_3 and O_2 . Around 60 m deep is when O_2 becomes limiting and NH_3 consumption rates start to zero entirely. Little NH_3 reduction occurs in this zone, but NH_2OH that diffuses from the outer layers is used to provide electrons for NO_2 reduction, which causes a jump in N_2O production (Sabba et al., 2017a, p. 4 & 5).

Moreover, NOB were regarded as having a negative effect on the production of N_2O in nitrifying biofilms in this study. Although NOB do not directly create N_2O , they can influence AOB to make it by changing the environment. If NOB are added with a concentration of 15g/L into the system with the availability of 50 g/L of AOB, the N_2O emissions were recorded to increase because of the higher biomass, the higher O_2 gradient, as well as assisting in establishing an anoxic zone within the biofilm depth. Remarkably, even if the AOB density reduces to 35 g/L while retaining a total biofilm density of 50 g/L, the amount of N_2O generation is still higher than that of only AOB. These results suggested that NOB enhance N_2O emissions in a nitrifying biofilm (Sabba et al., 2017a, p. 5).

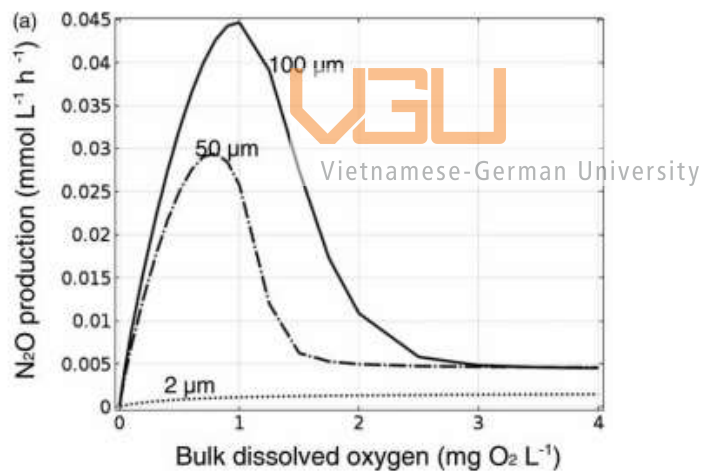

Figure 13. The influence of DO concentration and biofilm thickness on N_2O production (Sabba et al., 2017a, p. 4).

In denitrifying biofilms, emissions from the 5 μm biofilm were higher than those from the thicker biofilms at low NO_3^- concentrations because of the partial NO_3^- penetration inside the biofilm depth. Higher NO_3^- concentrations are necessary for denitrification rates to be as high as possible throughout thicker biofilms. Fig. 14a shows that at NO_3^- concentration around 3 mg N/L, N_2O production of the 5 μm biofilm was 0.0012 mmol/L.h, higher than that of 50 μm and 400 μm biofilms. However, N_2O production of 50 μm and 400 μm biofilms exceeded that of the 5 μm biofilm when NO_3^- concentration approached 5 and 7.5 mmol/L.h,

respectively. Similarly, the 5 μm biofilms produced more N_2O per unit reactor capacity at low O_2 concentrations than the thicker biofilms. In specific, at almost zero O_2 concentrations, the 5 μm biofilms produced their highest amount of N_2O emissions, while at roughly 0.1 $\text{mg O}_2/\text{L}$, the N_2O emissions began a sharp decline that eventually reached zero at about 0.3 $\text{mg O}_2/\text{L}$. In contrast, N_2O production of biofilms thickness of 50 μm and 400 μm is always higher than that of 5 μm biofilms and reduce to nearly zero at around 7 $\text{mg O}_2/\text{L}$ (50 μm biofilms), while N_2O production of 400 μm biofilms slightly declined, almost stayed around 0.0016–0.0017 mmol/L.h (Fig. 14b). These findings show that thicker biofilms generated higher a amount of N_2O in most cases of denitrifying biofilms.

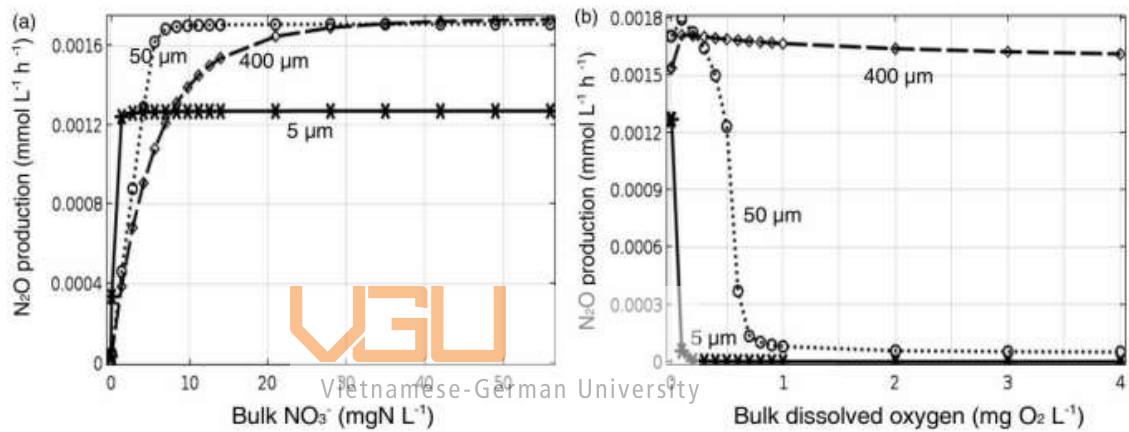

Figure 14. N_2O production of various biofilm thicknesses at different nitrate concentrations (a) and DO concentrations (b) (Sabba et al., 2017a, p. 6).

4.2. Comparison of nitrification – denitrification and traditional nitrification - denitrification

In nitrification – denitrification processes, NH_3 is oxidized to NO_2^- by AOB (nitrification); after that, the NO_2^- should be further denitrified (denitrification), omitting the production of NO_3^- . The benefits of this process over conventional activated sludge include, theoretically, a 25% reduction in oxygen consumption in the aerobic stage, 40% reduction in COD demand in the anoxic phase, 20% decline in CO_2 emissions, as well a 30% reduction in sludge production (Gustavsson et al., 2010, p. 180). However, the effect of N_2O emission reduction should be taken into consideration because numerous studies have suggested that nitrification – denitrification reactions cause significant N_2O emissions (Zou et al., 2022, p. 1).

Similar to traditional nitrification – denitrification, NH_2OH oxidation, nitrifier denitrification, and heterotrophic denitrification are the three pathways of N_2O production in nitrification – denitrification process (Frison et al., 2015, p. 2). Another study investigated nitrification – denitrification, nitrification – denitrification, and partial nitrification – anammox processes and confirmed that nitrification was the main contributor to N_2O generation due to the NO_2^- accumulation caused by the imbalance in the former and the latter steps (Desloover et al., 2012, p. 474 & 475). Therefore, the strategies to mitigate N_2O emissions are almost the same as conventional processes, such as ensuring adequate aeration throughout the nitrification stage and using a nitrogen loading rate that does not exceed the nitrogen removal capacity of the system to prevent ammonium and nitrite from building up (Frison et al., 2015, p. 8).

A study of NO and N_2O emissions from lab-scale bioreactors with the transient conditions of nitrification – denitrification and nitrification – denitrification showed an alteration in N_2O emissions between the two conditions (Fig.15). During full-nitrification, NO and N_2O emissions were $0.010 \pm 0.010\%$ and $0.13 \pm 0.24\%$, respectively of the influent NH_3 loading. High N_2O and NO emissions were seen after the transition from full to partial nitrification because of the sudden change in N-conversion. The emissions of NO and N_2O respectively during this period were $0.18 \pm 0.070\%$ and $1.9 \pm 1.1\%$ of influent ammonia. The greater emissions during the partial nitrification transition phase are logical to earlier results that changes in oxygen or ammonium concentrations are particularly responsible for the formation of N_2O and NO . However, under the steady state of partial - nitrification, NO and N_2O emissions were $0.070 \pm 0.030\%$ and $0.57 \pm 0.17\%$ respectively, of the influent NH_3 loading, still higher than that under full – nitrification (Ahn et al., 2011, p. 2737).

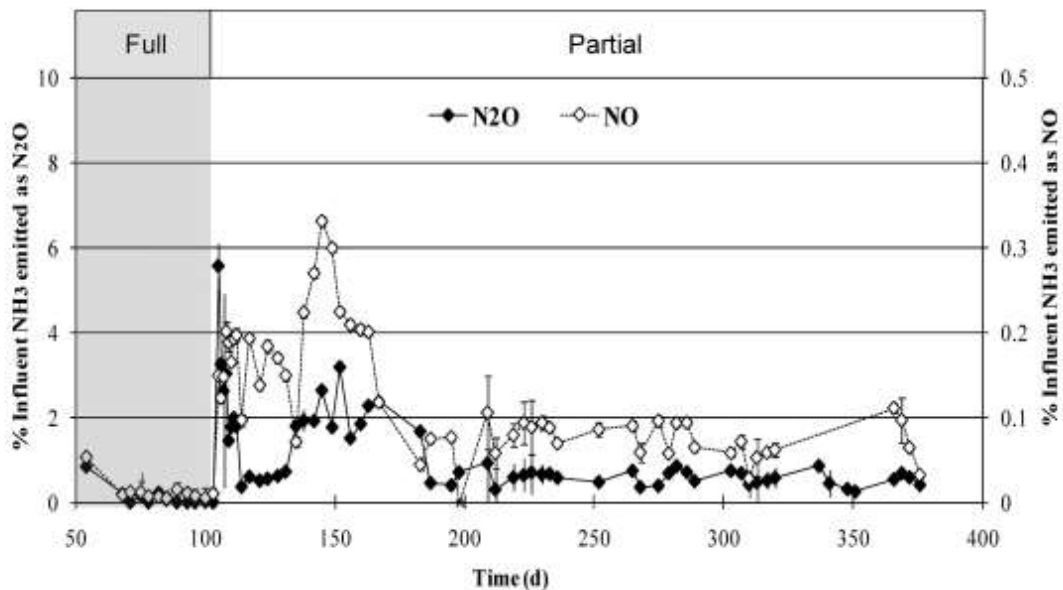

Figure 15. A comparison of N₂O emission in full-nitrification and partial-nitrification (Ahn et al., 2011, p. 2738).

4.3. Comparison of conventional activated sludge (CAS) and aerobic granular sludge (AGS).

Vietnamese-German University

Although the N₂O emissions from conventional activated sludge have been thoroughly investigated, there is still little knowledge about the N₂O emissions from the secondary treatment alternative known as aerobic granular sludge. AGS is characterized by the creation of zones with various dissolved oxygen and substrate gradients, which enables simultaneous nitrification and denitrification (SND) (Jahn et al., 2019, p. 1304), and substitutes rapid-settling microbial granules for floc-based activated sludge (Thwaites et al., 2017, p. 409). AGS is made up of thick, self-immobilized microbial granules with a high biopolymer content, a compact microbial structure, and faster settling velocities. Granular microbial growth enables phosphate removal from wastewater in a single treatment tank, effective biomass water separation, increased biomass concentrations in the bioreactor, and granular microbial growth. As a result, the AGS process reduces land footprint around 50% - 75% and energy consumption 30% - 48% less than CAS method (Nancharaiah et al., 2019, p. 57). To ensure the favorable effects of AGS, such as enhanced capacity and stable nutrient removal, it is also necessary to evaluate the N₂O emissions performance of AGS. One essential requirement for the operation of AGS is the introduction of an anaerobic feed, which favors microorganisms that store readily

available organic carbon, such as PAOs and GAOs, giving them a competitive edge against filamentous bacteria and floc-forming organisms (Bassin et al., 2012, p. 3805 & 3806; Liu et al., 2006, p. 125). Contrarily, CAS is fed aerobically, hence this variation in feeding method may have substantial but unidentified effects on the N₂O emissions profile of AGS. For instance, using anaerobic feed causes the beginning of the aerobic phase to have higher initial concentrations of organic carbon and nitrogen. Low DO and these situations may make the hydroxylamine and AOB denitrification processes more effective at producing N₂O (Thwaites et al., 2021, pp. 1-3). Based on the matching DO for AGS, it was challenging to maintain appropriate DO levels throughout the early phases of the aerobic phase for all loads. The initial high loads generated by the anaerobic feed were blamed for the DO lag. In contrast, the CAS system combined reactor feeding and aeration allowed for the achievement of acceptable and more stable DO levels far earlier. Low DO concentrations and high biomass ammonium loading in AGS can create favorable circumstances for N₂O generation, especially through the AOB-mediated denitrification pathway (Thwaites et al., 2021, p. 6). This theory is supported by the greater accumulation of NO₂⁻ in the AGS system, given that NO₂⁻ replaces N₂ as the final electron acceptor in nitrifier denitrification (Tallec et al., 2006, p. 2973).

In a study of treating high salinity municipal wastewater at the pilot scale and continuously monitoring emissions, it was revealed that N₂O emission factors range from 2.3 to 6.8% of total kjeldahl nitrogen (TKN) load (Van Den Akker et al., 2015, p. 144). Besides, in a subtropical environment in a pilot-scale SBR with AGS supplied with domestic wastewater, N₂O conversion rates were 0.47 and 5.28% of TN (Daudt et al., 2019, p. 216). However, neither study made a direct comparison between an identically loaded CAS-operated reactor and the N₂O emissions from AGS. Research by Thwaites et al. (2021) examined the impact of loading on N₂O generation and compared it between AGS and CAS processes. There was no significant difference in N₂O emissions between CAS and AGS at COD loads of less than 0.6 kg COD/m³/d. However, N₂O emissions from the AGS were statistically larger than emissions from CAS if the COD loading was elevated exceeding 0.6 kg COD/m³/d. These findings imply that higher loadings had less of an effect on N₂O emissions from the CAS system (Thwaites et al., 2021, p. 5).

On the other hand, N₂O emission in AGS is dependent on the organic loading rate (OLR) and DO conditions. At the beginning of the aeration, increasing loads result in increased AOB

activity and N₂O formation from autotrophic nitrification. Additionally, the increased oxygen intake via the outer zones as a result of the greater OLR results in expanded anoxic zones inside the granules. This would account for the elevated SND activity as well as the enhanced N₂O production during heterotrophic denitrification. Moreover, it was discovered that the aeration approach encouraged nitrite accumulation and elevated N₂O emissions. Nitrite plays as an indicator of strong AOB activity and can directly affect the generation of N₂O. It was discovered that the alternate aeration method reduced N₂O emissions and was more effective at removing TN. Anoxic-aerobic conditions should be preferred for the operation of the AGS system in light of the intended low N₂O emissions (Jahn et al., 2019, pp. 1310-1313).

4.4. Summary of process comparisons

The differences of N₂O production from various processes are summarized in table 3.

Table 3. Processes comparison summary

Suspended growth system	Attached growth system
<p>Because of substrate gradients, the generation and transport of NH₂OH, it has been discovered that AOB function much differently in biofilm systems than they do in suspended growth systems.</p> <p>If thin biofilms represent a suspended growth system, thicker biofilms generate more N₂O than thin biofilms and NOB enhance N₂O emissions in nitrifying biofilms. Besides, in most cases of denitrifying biofilms, thicker biofilms generated higher a amount of N₂O despite that at low NO₃⁻ and DO concentrations, emissions from the thin biofilms were higher than those from the thicker biofilms.</p>	
Nitrification - denitrification	Nitritation - denitritation
<p>In general, N₂O emission in nitritation – denitritation is higher than those in nitrification – denitrification process.</p> <p>NO₂⁻ accumulation is the main contributor to N₂O emissions. The methods for reducing N₂O emissions are almost identical in the two processes, such as making sure there is enough</p>	

aeration during the nitrification or nitrification stage and utilizing a nitrogen loading rate that does not exceed the system capacity for removing nitrogen.

Conventional activated sludge

Aerobic granular sludge

The N₂O emissions pattern change significantly depending on the feeding strategy: anaerobic feed for AGS and aerobic feed for CAS.

Similar to CAS, conditions for DO and organic loading rate affect N₂O emission in AGS.

At lower COD, there was no appreciable difference in N₂O emissions between CAS and AGS. However, if the COD loading was increased, N₂O emissions from the AGS were statistically greater than emissions from CAS.



Vietnamese-German University

CHAPTER 5: Current research on N₂O emission measuring and calculation models.

Generally, N₂O emissions are diffused in nature, occur in several process units and technologies, and take on various physical forms, so measuring as well as quantifying air emissions from WWTPs is a challenging task. As a result, many techniques have been created to calculate and assess N₂O emissions in WWTPs. The method of Intergovernmental Panel on Climate Change (IPCC) is the international standard and the most popular empirical technique for measuring N₂O emission in WWTPs. The IPCC revised the 2006 standards in 2019, taking additional factors including total nitrogen, the kind of treatment, and the nitrogen in the sludge into account. More empirical methods have been developed and proposed in recent years based on the guidelines to quantify the N₂O emissions in WWTPs, using various operating parameters to know the emission without the need to conduct side-by-side measurement campaigns or use technologies (Ramírez-Melgarejo et al., 2020, p. 2). This chapter introduces N₂O emissions estimation methodologies based on protein consumption and measuring models to record and calculate N₂O emitted in the gas phase as well as liquid phase.

5.1. N₂O emission estimation methods based on capita protein consumption.

5.1.1. Estimation method by Seema Das (2011)

In the lack of precise emissions measurements, the calculation techniques for estimating emissions apply one or more emission factor(s) (EF) in accordance with conventional GHG accounting principles. The EFs use wastewater treatment parameters that may be measured or approximated with some degree of accuracy, such as influent total nitrogen (TN) load (de Haas et al., 2022, p. 2) or capita protein consumption. In this part, N₂O emissions have been estimated based on emission factor (g N₂O/person.a) and per capita protein consumption (kg/person.a) (Das, 2011, pp. 54-58). The N₂O production from WWTP is calculated according to the following equation:

$$\text{N}_2\text{O emission from wastewater} = \text{N}_2\text{O emission (direct)} + \text{N}_2\text{O emission (indirect)} \quad (5)$$

The N₂O direct emission is the emission from on-site nitrification and denitrification processes and calculated by the following equation:

$$E_{N_2O, \text{direct}} = W_{\text{pop}} * EF_1 * CF \quad (6)$$

Where:

- $E_{N_2O, \text{direct}}$: the N_2O direct emission (kg N_2O/a)
- W_{pop} : the connected population (people)
- EF_1 : emission factor = 3.2 g $N_2O/person.a$, which is the ratio of the total emission (g N_2O/a) to W_{pop} (people)
- CF : correction factor = 1.14, which is the ratio of average concentration (35 mg TKN/L) for municipal wastewater and average nitrogen loading rate (40 mg/L)

The indirect emission after effluent discharge into aquatic ecosystems is calculated based on the following equation:

$$E_{N_2O, \text{indirect}} = [(P * NP_{\text{frac}} * F * W_{\text{pop}}) - Nit_{\text{ww}} - Nit_{\text{sludge}}] * EF_2 * 44/28 \quad (7)$$

Where

- $E_{N_2O, \text{indirect}}$: the N_2O indirect emission from effluent (kg N_2O/a)
- P : capita protein consumption annually (kg/person.a) = 38 kg/person.a.
- NP_{frac} : fraction of nitrogen in protein = 0.16 kg N/kg protein.
- F : non-consumption protein factor in municipal wastewater = 1.14.
- $Nit_{\text{ww}} = W_{\text{pop}} * EF_1 * CF * 28/44$: the quantity of N removed by wastewater treatment processes
- Nit_{sludge} : N sludge not going to the receiving water body (kg N/a) = 0.12 * P_{biomass}
- EF_2 : emission factor (kg $N_2O-N/ kg \text{sewage} - N \text{ produced}$),
 $EF_2 = 0.01 \text{ kg } N_2O-N/ \text{ kg } \text{sewage} - N \text{ produced}$
- 44/28: molecular mass ratio of N_2O to N_2 .

5.1.2. Estimation method by IPCC (2019)

Nitrous oxide could be emissions from WWTPs and emissions from receiving aquatic ecosystems. Both discharges of wastewater treatment effluent and wastewater that has not been treated into aquatic habitats cause emissions. It is significant to remember that emissions are influenced by the oxygenation level and degree of nutrient impact on the aquatic environment. Based on studies where real emissions were assessed, the most recent IPCC Guidelines (IPCC, 2019) indicate the large range in N_2O EF for wastewater treatment. The implementation of

"country-specific" methodologies for N₂O measurement from wastewater treatment and discharge is permitted (de Haas et al., 2022, p. 2). The (IPCC, 2019) has described the steps of measuring N₂O emissions from domestic wastewater, shown as follows:

Step 1: Use the equation (8) and the equation (9) to calculate the total nitrogen in wastewater and wastewater effluent, respectively.

Total nitrogen in wastewater:

$$TN_i = (P_{treatment_i} * Protein * F_{NPR} * N_{HH} * F_{NON-CON} * F_{IND-COM}) \quad (8)$$

Where

- i: wastewater treatment pathway
- TN_i : total nitrogen per year in wastewater for treatment pathway i (kg N/a)
- $P_{treatment_i}$: total population that the treatment approach i serves (people/a)
- Protein: annual per capita protein consumption (kg protein/person.a)
- F_{NPR} : nitrogen fraction in protein (kg N/kg protein), $F_{NPR} = 0.16$ kg N/kg protein
- N_{HH} : additional nitrogen supplied to the wastewater via household products, $N_{HH, default} = 1.1$ (see table 4)
- $F_{NON-CON}$: nitrogen content of non-consumed protein discharged in sewage system (kg N/kg N) (see table 4)
- $F_{IND-COM}$: factor for co-discharged protein from commercial and industrial sources into the sewage system (kg N/kg N)

In case of no data for protein consumed, it is estimated by equation (9):

$$Protein = Protein_{supply} * FPC \quad (9)$$

Where

- $Protein_{supply}$: annual per capita protein supply (kg protein/person.a)

FPC: fraction of protein consumed (see table 4)

Nitrogen in wastewater effluent:

$$N_{Effluent} = \sum_i [(TN_i * T_i) * (1 - N_{REM,i})] \quad (10)$$

Where

- $N_{Effluent}$: nitrogen in wastewater effluent released into aquatic ecosystems during the inventory year (kg N/a)
- T_i : degree of treatment system i usage in the inventory year (see table A.1, appendix)
- $N_{REM,i}$: percent of the total nitrogen eliminated from wastewater during treatment (see table 5)

Table 4. Default values for municipal wastewater by regions (IPCC, 2019).

Region	Protein consumed (fraction of protein supply)	$F_{NON-CON}$ (kg N/kg N)	N_{HH}
Europe	0.85	1.09	1.08
Industrialized Asia	0.86	1.08	No data
South and Southeast Asia	0.96	1.02	1.13 (India)
North America and Oceania	0.8	1.13	1.17 (USA), 1.07 (Australia)
Latin America	0.92	1.04	No data
North Africa, West and central Asia	0.9	1.06	No data
Sub-Saharan Africa	0.98	1.01	No data

Table 5. Fraction of nitrogen removal based on treatment pathway (IPCC, 2019).

Treatment pathway	Default	Range
No treatment	0	0
Septic tank	0.15	0.1 – 0.25
Septic tank + land dispersal field	0.68	0.62 – 0.73
Lantrine	0.12	0.07 – 0.21
Primary (mechanical)	0.1	0.05 – 0.2
Secondary (biological)	0.4	0.35 – 0.55
Tertiary (advanced biological)	0.8	0.45 – 0.85

Step 2: Calculate the emissions from wastewater treatment using equation (11), then sum up the results for each treatment pathway.

N₂O emissions from WWTPs:

$$N_2O_{WWTPs} = \left[\sum_{i,j} (U_j * T_{i,j} * EF_i) \right] * TN_i * \frac{44}{28} \quad (11)$$

Where

- N_2O_{WWTPs} : N₂O emissions from domestic WWTPs in inventory year (kg N₂O/a)
- U_j : population fraction in income group j (see table A.1, appendix)
- $T_{i,j}$: degree of treatment pathway utilization for each income group (see table A.1, appendix)
- j: income group
- EF_i : emission factor for treatment pathway i (kg N₂O-N/kg N) (see table 6)

Step 3: Calculate effluent emissions using equation (12).

N₂O emissions from wastewater effluent:

$$N_2O_{Effluent} = N_{Effluent} * EF_{Effluent} * \frac{44}{28} \quad (12)$$

Where

- $N_2O_{Effluent}$: N₂O emissions from wastewater effluent in inventory year (kg N₂O/a)
- $EF_{Effluent}$: N₂O emission factor from wastewater effluent released to water body (kg N₂O-N/kg N) (see table 6).

Total N₂O emissions is the sum of N₂O emissions from WWTPs and wastewater effluent, which is calculated by equation (13):

$$N_2O_{Total} = N_2O_{WWTPs} + N_2O_{Effluent} \quad (13)$$

Table 6. Emission factor for treatment pathways in WWTPs and wastewater effluent (IPCC, 2019).

Type of treatment/ discharge pathway	Description	EF (kg N ₂ O -N/kg N)	Range
Emission factor from wastewater effluent $EF_{Effluent}$			
Nutrient-impacted and/ or hypoxic freshwater, marine, and estuarine environments	Higher emissions are linked to areas where there are stagnant conditions or nutrient-impacted/hypoxic water	0.019	0.0041 – 0.091
Freshwater, marine, and estuarine discharge	According to certain assumptions about the occurrence of nitrification and denitrification in rivers and estuaries, and limited field data	0.005	0.0005 – 0.075
Emission factor for treatment pathway EF_t			
Anaerobic reactor	N ₂ O is not significant	0	0 – 0.001
Anaerobic lagoon	N ₂ O is not significant	0	0 – 0.001
Aerobic treatment plants	N ₂ O is fluctuating	0.016	0.00016 – 0.045
Septic tank	N ₂ O is not significant	0	0 – 0.001
Septic tank + land dispersal field	The soil dispersal system emits N ₂ O.	0.0045	0 – 0.001
Latrine	N ₂ O is not significant	0	0 – 0.001

5.2. Measuring methods

The carbon footprint of operations at WWTPs can be greatly increased by direct N₂O emissions during the biological nitrogen removal processes. According to (Vasilaki et al., 2019, p. 392), the contentious theoretical approaches for the N₂O calculation have been replaced by more recent on-site observations of N₂O emissions at WWTPs. The understanding of the N₂O production pathways and the process triggering operational circumstances is improved by the large-scale N₂O monitoring campaigns. Finding improved process control methods to reduce N₂O emissions from wastewater treatment plants could be assisted by reliable N₂O monitoring. However, it is still difficult and expensive to quantify the emissions and comprehend the long-term behavior of N₂O fluxes in WWTPs. There are still challenges in the establishment of emission factor databases and the comparison of N₂O emissions. The findings showed that the EF range might be impacted by the duration of monitoring programs. This section focuses on introducing measuring methods, including off gas and dissolved gas, and calculation models to estimate N₂O emissions step by step.

Overall, to measure N₂O emission in gas-phase, a closed floating chamber is typically used to catch the N₂O released from activated sludge tanks. Air was blown into the chamber headspace for sampling during non-aerated phases and dissolved N₂O was removed from the liquid phase into the gas during aeration. In offline measurement, samples were drawn into 20 ml nylon syringes from the chamber headspace at predetermined intervals. A gas chromatography with an electron capture detector was used for the N₂O analysis. However, grab samples taken offline are unable to detect variability in N₂O emission patterns, causing the N₂O emissions to be over- or under-estimated. In recent years, online monitoring has been used to accurately quantify N₂O emissions from WWTPs. The ratio between the mass of emitted N₂O-N and the amount of influent total Kjeldahl nitrogen load or the amount of nitrogen removed during nitrification and denitrification is commonly used to depict the emission factors. The observed N₂O concentration, the gas flow rate out of the chamber, and the covered cross-sectional area are utilized to determine the mass of the released N₂O-N. On the other hand, to measure N₂O emission in liquid-phase, off-line grab samples followed by GC analysis are used. A vacuum vial is filled with a liquid sample containing N₂O, and the liquid-gas equilibrium is then allowed to occur. The concentration of liquid N₂O is then determined using Henry's law after measuring the concentration of gas-phase N₂O in the vial. The total amount of N₂O in the sample is calculated by dividing the total volume of the liquid by the total amount of N₂O present in both

the liquid and gas phases. Moreover, a microsensor is also utilized to directly monitor dissolved N_2O concentration in the liquid-phase. The extreme sensitivity of N_2O microsensors, despite their low detection limit, makes them susceptible to interferences, especially in full-scale measurements. The dependability of the results is greatly improved by combining the analyses of the microsensor and the GC-vial techniques. To identify the spatial fluctuation in N_2O concentration, liquid-phase detection at numerous places is required, much as the gas-phase analysis. Liquid-phase measurement is used to calculate N_2O flux. However, in full-scale facilities, it is not an easy task to estimate the mass transfer coefficient between the liquid and gas phases. As a result, rather than being used for quantification, the liquid-phase N_2O data are mainly employed to study the processes involved in N_2O formation and emission. For mass balance, correlation analysis of N_2O emission fluxes, and model construction, additional parameters including pH, DO, temperature, total suspended solids, and volatile suspended solids (VSS) are frequently recorded at sampling points and at the wastewater influent (Foley et al., 2010, pp. 835-837; Law et al., 2012b, p. 1267 & 1268).

5.2.1. Off-gas measuring methods

This part illustrates the two methods for monitoring off-gas. Both methods have in common collecting gas from reactors, transferring by tubes and pressure, temperature, and concentration recording by analyzers.

The first method is used to monitor off-gas concentration emitted from covered reactors. Particularly, the gases were taken by a sampling tube, transferred into a conditioning unit and analyzed using infrared analysis. The opening of solenoid valves that directed the flow of gas from each reactor to the N_2O analyzer was controlled by a Programmable Logic Controller (PLC), which also controlled the gas sampling from each reactor. In order to cut off the gas sources in certain time intervals, the PLC unit used data that was gathered three times while the solenoid was open. N_2O concentration, gas temperature, flow rate, and pressure are all recorded by the device. A data logging hot wire thermos-anemometer was used to record velocity and air temperature, and a Fourier-transform infrared analyzer was used to detect emitted N_2O concentrations after the velocity measurements. Based on data gathered from online monitoring of the off-gas N_2O content, gas flow, and gas temperature, N_2O flux was computed. Similar to prior studies, all cycle phases other than the aerobic phase were thought

to produce insignificant emissions (Myers et al., 2021, p. 643; Thwaites et al., 2021, p. 3). This model was used to monitor the N₂O emissions in CAS and AGS systems (Fig. 16).

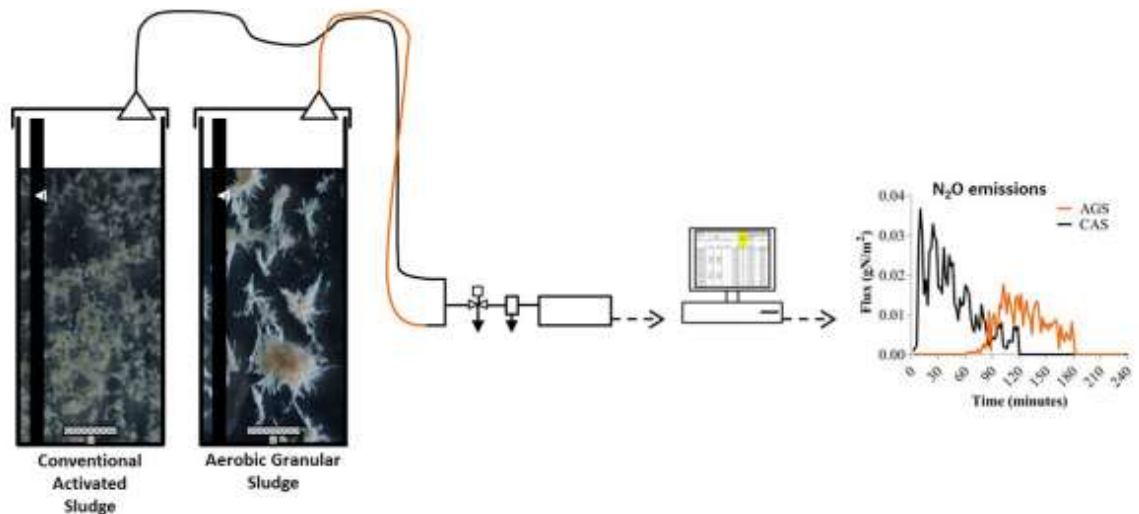

Figure 16. A basic layout of off-gas measuring method (Thwaites et al., 2021).

The second method demonstrates the distribution and installation of collection hoods in an SBR (Duan et al., 2020, p. 2 & 3). Numerous online sample stations with floating hoods were chosen to capture the potential fluctuations in N₂O emissions. Locations for the gas phase sample were particularly chosen to cover the inlet region of the flue gas, the center of the aeration tank, and the effluent output area (hood 1, hood 2, and hood 3, respectively). The hoods initially collected the gas that was released, which was then transferred to the central analyzing unit via a poly pipe that had a gentle slope for collecting and removing condensate. Three gas lines were set up to regulate the gas drawn from the three hoods, each equipped with a gas flow meter, a temperature sensor, and a pressure sensor. Three direct-acting solenoid valves each controlled one of the gas lines. The central regulating device for the cyclic opening and closing of the valves was the data logger. This device records data from the temperature and pressure sensors, gas analyzer, and flow meters, and uses solid state relays to control the valves using digital output signals. The N₂O analyzer then measured the collected gas (Fig.17). Pressure, temperature, and gas concentration were all recorded. Gas chromatography analysis of sampled gases was used to independently verify the N₂O analyzer values.

The N₂O emissions and emission factor were calculated according to equation (14) and (15) (Duan et al., 2020, p. 3 & 4):

$$N_2O \text{ emissions} = \sum(C_{N_2O-N,gas} * Q_{air} * \Delta t) \quad (14)$$

Where

- $C_{N_2O-N,gas}$: N_2O off-gas concentration (mg N_2O -N/L)
- Q_{air} : airflow rate of aeration or or airflow rate recorded by analyzer during anoxic phase (L/h)
- Δt : time during off-gas concentration measured by analyzer (h)

Based on the N_2O emissions and the influent nitrogen loadings, emission factor was calculated:

$$EF_{N_2O} = \frac{N_2O \text{ emissions}}{\text{influent nitrogen loadings}} * 100\% \quad (15)$$

Where

- EF_{N_2O} : N_2O emission factor (%)
- Influent nitrogen loadings = total TKN loading to the plant (mg N/L)

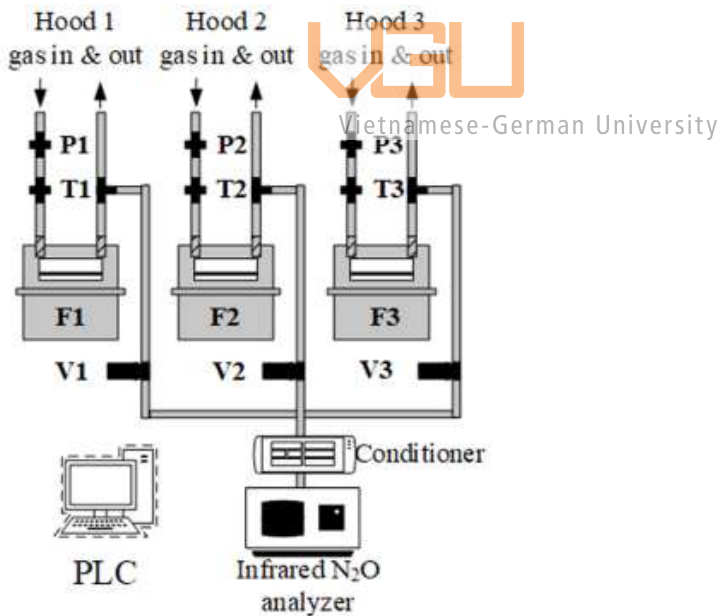

P: pressure transmitters, T: temperature sensors, F: gas meters, V: direct-acting solenoid.

Figure 17. Collection hoods installation in off-gas monitoring (Duan et al., 2020, p. 3).

5.2.2. Dissolved gas measuring methods

In the field of environmental protection, dissolved gas concentration measurement is crucial. Online DO probes are used often for aeration management, reducing excessive energy use and related indirect CO₂ emissions. Online gas phase monitoring has demonstrated its accuracy and practicality for calculating N₂O emissions. However, because N₂O is generated in the liquid phase, determining the concentration of dissolved N₂O is likely to reveal more details about the processes that cause N₂O to occur, providing additional chances for prevention and control. The two most common methods for determining the concentration of dissolved N₂O are grab sampling-gas chromatography analysis, stripping method or utilizing a Clark-type electrode (Mampaey et al., 2015, p. 1680 & 1681).

5.2.2.1. Stripping gas method

To measure dissolved N₂O by stripping method, the monitoring principle involves the use of a gas stripping device, the evaluation of which depends on the examination of the N₂O level in the stripped gas phase after a continuous feeding of reactor liquid via a stripping flask. It is suggested technique for online monitoring of dissolved gasses relies on a gas stripping apparatus made up of a stripping flask and a scum trap flask, as depicted in Fig. 18. The stripping flask is repeatedly supplied with a liquid sample stream, in this example from the reactor, at a constant flow rate Q_L while maintaining a steady liquid volume V_L in the stripping flask. An empty bottle called the scum trap flask is used to catch condensate scum from the stripping flask. In the stripping flask, nitrogen is employed as a stripping gas via fine bubble aeration with a constant flow rate Q_G^{in} . An online gas phase analyzer is used to examine the gas outflow of the gas stripping equipment (Mampaey et al., 2015, p. 1681).

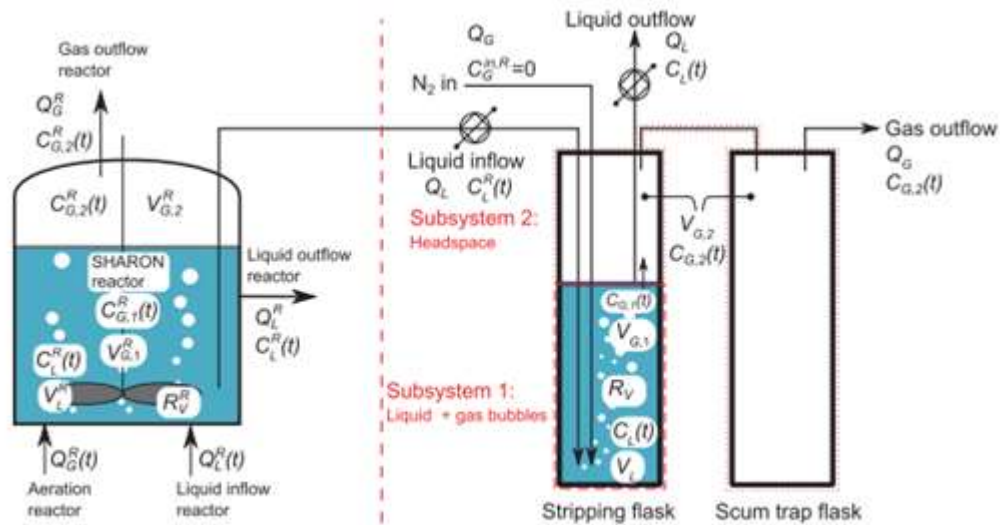

Figure 18. Gas tripping device modelling (Mampaey et al., 2015, p. 1681).

5.2.2.2. Clark-type electrode utilizing method

Measuring dissolved N_2O in the water phase is one strategy, allowing for direct monitoring of process changes and their effects on N_2O generation. A Clark-type microsensor from Unisense Environment (Denmark) was utilized to measure the dissolved N_2O in the water phase (Fig.19). A guard cathode and an internal reference are features of Clark-type sensors. N_2O passes through the sensor tip membrane during the analysis and is reduced at the metal cathode surface, creating signals. On a computer, the online signal can be recorded. The extreme sensitivity of N_2O microsensors, despite their low detection limit, makes them susceptible to interferences, notably in full-scale investigations. The dependability of the results is greatly increased by combining the studies of the GC analysis and microsensor procedures (Law et al., 2012b, p. 1268).



Figure 19. Clark-type electrode and measuring system (Unisense Environment, 2022).

The N_2O water sensor was sited around the basin at various points during the measurement period to collect data in both aerated and non-aerated areas. The N_2O Calibration Kit issued by Unisense Environment was used to perform a basic 2-point calibration on the sensor once a week. Based on mathematical models that characterize the recycling of nitrogen in nitrification, and denitrification systems, N_2O emissions rates in the non-aerated and aerated zones were calculated (Baresel et al., 2016, p. 3). In particular, N_2O emission rate was calculated based on following equations:

In aerated zones:

$$r_{N_2O} = H_{N_2O} * S_{N_2O} * \left(1 - e^{-\frac{k_L a_{N_2O} * V_R}{H_{N_2O} * Q_A}} \right) * \frac{Q_A}{V_R} \quad (16)$$

In anoxic zones:

$$r_{N_2O} = k_L a_{N_2O, T_{process}}^{anoxic} * \left(S_{N_2O} - \frac{c_{N_2O, air}}{H_{N_2O}} \right) \quad (17)$$

Where

- r_{N_2O} : N₂O emission rate (mg N₂O-N/m³.d)
- H_{N_2O} : Henry'law constant
- S_{N_2O} : concentration of dissolved N₂O (mg N₂O-N/m³)
- V_R : aerated zone volume (m³)
- Q_A : airflow rate through reactor (m³/d)
- $k_L a_{N_2O}$: N₂O mass transfer coefficient (d⁻¹)
- $k_L a_{N_2O, T_{process}}^{anoxic}$: N₂O mass transfer coefficient in anoxic zones (d⁻¹),
 $k_L a_{N_2O, T_{process}}^{anoxic} = 2-4 \text{ d}^{-1}$
- $c_{N_2O, air}$: N₂O concentration in air (mg/m³)

The Henry'law constant is calculated according to the following equations:

$$H_{N_2O} = \frac{1}{k_H * R * (T_{Process} + 273.15) * 10^3} \quad (18)$$

$$k_H = k_H^0 * e^{\left[\frac{-\Delta solnH}{R} * \left(\frac{1}{T_{Process}} * \frac{1}{T^0} \right) \right]} \quad (19)$$

Where

- k_H^0 : Henry's constant of N₂O at standard temperature (mol/L.hPa),
 $k_H^0 = 0.0247 \text{ mol/L.hPa}$.
- R: gas constant (m³ hPa/mol.K), $R = 8.314 * 10^{-5} \text{ m}^3 \text{ hPa/mol.K}$
- T^0 : standard temperature (25°C)
- $T_{Process}$: process water temperature (°C)
- $\Delta solnH$: the enthalpy of the solution (K), $\Delta solnH = -2,675K$

The estimation of N₂O emissions require the value of N₂O mass transfer coefficient, could be calculated by empirical experiments at 20°C (Foley et al., 2010, p. 837):

$$k_L a_{N_2O} = k_L a_{N_2O, 20^\circ C} * (1.024)^{(T_{Process} - 20)} \quad (20)$$

$$k_L a_{N_2O, 20^\circ C} = \left(\frac{D_R}{D_L} \right)^{-0.49} * (34,500 * v_g)^{0.86} \quad (21)$$

With:

$$v_g \approx \frac{Q_A}{A_{aerated\ area}} \quad (22)$$

Where:

- D_R : depth over the diffuser of the reactor (m)
- D_L : depth of the lab tripping column (m)
- v_g : superficial gas velocity of the reactor (m/s)
- $A_{aerated\ area}$: aeration area of the reactor (m²)

On the other hand, the ability to estimate N₂O mass transfer coefficient $k_L a_{N_2O, 20^\circ C}$ from known O₂ mass transfer coefficient without having to know the N₂O and O₂ diffusivities in each wastewater matrix was also calculated by the methodology of (Maktabifard et al., 2022, Appendix). Based on the oxygen transfer rate (OTR) under field conditions, the $k_L a_{O_2}$ was calculated during aerobic phases to keep the DO at the required set-point:

$$k_L a_{O_2, 20^\circ C} = \left(\frac{OTR_{Liq-gas}/V_R}{DO_{sat}-DO} \right) + \left(\frac{q_o \cdot X}{DO_{sat}-DO} \right) \quad (23)$$

Where



Vietnamese-German University

- $k_L a_{O_2, 20^\circ C}$: Oxygen mass transfer coefficient at 20 °C (d⁻¹)
- $OTR_{Liq-gas}$: oxygen transfer rate, reported by plant operators (kg O₂/d)
- DO_{sat} : concentration of oxygen saturation in water at 20 °C (kg O₂/m³)
- DO: concentration of oxygen measured in the WWTP (kg O₂/m³)
- $q_o \cdot X$: oxygen uptake rate (kg O₂/d)

The mass transfer coefficient in pure water is described by the $k_L a$ estimation of equation (23). However, impurities, wastewater salinity, and fouling of the air diffusers are factors affecting this estimation in practical WWTP, and are normally taken into account when estimating $k_L a$:

$$k_L a_{O_2, 20^\circ C} = \left(\frac{OTR/V_R}{\alpha(\beta DO_{sat}-DO)*F} \right) + \left(\frac{q_o \cdot X}{\alpha(\beta DO_{sat}-DO)*F} \right) \quad (24)$$

Where

- α : transfer rate reduction by impurities (-)
- β : transfer rate reduction by salinity (-)

- F: transfer rate reduction by fouling in air diffusers (-)

N₂O mass transfer coefficient at 20 °C is calculated by the following equations (Foley et al., 2010, p. 837):

$$k_L a_{N_2O, 20^\circ C} = k_L a_{O_2, 20^\circ C} * \sqrt{\frac{D_{F N_2O}}{D_{F O_2}}} \quad (25)$$

Where

- $D_{F N_2O}$: N₂O molecular diffusivity in water at 20 °C (m²/s), $D_{F N_2O} = 1.84 * 10^{-9}$ m²/s (Tamimi et al., 1994, p. 331)
- $D_{F O_2}$: O₂ molecular diffusivity in water at 20 °C (m²/s), $D_{F O_2} = 2 * 10^{-9}$ m²/s (Xing et al., 2014, p. 13)

Because the N₂O water sensor signal is influenced by the process temperature, it must be adjusted for variations from the calibration temperature. This is corrected by Unisense Environment using a standard temperature correction method for electrochemical sensors that has been adjusted to numerous temperature/concentration data sets. Therefore, concentration of dissolved N₂O is calculated by the following equation:

$$S_{N_2O} = S_{N_2O, T_{Process}} * (1.033)^{T_{Process} - T_{calibration}} \quad (26)$$

5.3. Summary of calculation methods

N₂O emissions could be estimated by both off-site methods by capita protein consumed and on-site methods by monitoring, measuring the off-gas and dissolved gas in liquid phase. Although the methods based on capita protein consumption are convenient to estimate the N₂O emissions from WWTPs and discharged effluent, estimating the amount of nitrogen in wastewater is uncertain given the statistical value of protein consumption per person (Ramírez-Melgarejo et al., 2020, p. 7). As a result, on-site observations of N₂O emissions at WWTPs have superseded theoretical methods for the N₂O computation. The extensive N₂O monitoring programs have increased the understanding of the N₂O production routes and the mechanism triggering operating situations. N₂O emissions from WWTPs have been precisely quantified via online monitoring. N₂O flux is calculated via liquid-phase measurement, the major method used to investigate the mechanisms underlying N₂O generation and emission.

CHAPTER 6: Approaches to prevent production

Studies and results of previous chapters create a premise and basis for this chapter. In particular, the first two chapters focus on introducing the N₂O emission pathways, microbial, and enzymes involved in each pathway as well as indicating the predominant process of N₂O production, which play a role as a general background for further research on N₂O emission during biological wastewater treatment. Chapter 3 analyses boundary conditions influencing on N₂O generation, brings a more specific point of view for these parameters, and could be an effective approach to mitigate N₂O formation. Chapter 4 is the comparison of different wastewater treatment processes, showing the conditions and processes emitting more N₂O, and recommends deeper research on these aspects. Chapter 5 demonstrates the methodologies of measuring, estimating, calculating the emissions, and could be a guideline for studies aiming at preventing N₂O production. It is essential to comprehend the fundamental factors that affect N₂O emissions as it allows the creation of suitable mitigation solutions. Therefore, based on the results obtained from the first five chapters, this chapter would summarize and propose appropriate strategies to mitigate N₂O production and emission.

6.1. DO and aeration control

DO needs to be controlled and maintained at a suitable concentration during nitrification and denitrification. Based on the linear correlation between DO, NO₂⁻ concentration, and N₂O production, the respective approaches have been proposed. In order to prevent NO₂⁻ accumulation, it should be ensured that the plant operates in a manner that respects the N-removal capacity of the system. Under aerobic conditions, N₂O formation is mostly attributed by NH₂OH oxidation when DO concentrations are high, while lower DO levels promote N₂O production via nitrifier denitrification. For nitrification to be completed, DO must be kept at the right level, which is typically approximately 2 mg/L. However, there will typically be a significant increase in electricity usage when the rate of aeration is increased to elevate the DO concentration. Additionally, the overall carbon footprint and N₂O stripping are impacted by the aeration regime. Operators should guarantee that the aeration rate is optimal for nitrification without significantly raising the plant's energy needs or causing intensive stripping. Therefore, adopting a step aeration technique, a microporous aeration technique, or control technologies of aeration flows through online monitoring of the DO concentration in the aerobic tank are some technical engineering innovations that are required in the actual operation of WWTPs in

order to resolve this contradiction (Massara et al., 2017, p. 120; Sun et al., 2015, p. 4228). For example, in a full-scale SBR system, the cycles with the long aerated phases have higher N₂O emissions. It was discovered that implementing a cycle configuration with intermittent aeration, with a sequence of 20–30 minute aerobic followed by brief anoxic phases, is an efficient mitigation technique for both N₂O emissions and energy needs. Because N₂O is consumed together with its precursors (NO and NO₂⁻) during the heterotrophic denitrification that took place in between the aerobic phases, the emissions decreased (Rodríguez-Caballero et al., 2015, p. 1). Furthermore, so as to limit the interference on a complete decrease from N₂O to N₂, it is also essential to inhibit the presence of DO during denitrification by regulating the DO concentration to a suitable level during nitrification (Lv et al., 2019, p. 3). However, intermittent aeration results in alteration in the environment and living conditions for microorganisms, which is one of the causes of incomplete denitrification.

On the other hand, in a full-scale sequencing batch reactor with long-term monitoring, the strategy of maintaining DO concentration at 0.5 mg/L, which allows the simultaneous occurrence of nitrification and denitrification, had been proposed and proved to be successful. The N₂O emission rate reduced from 0.9% to 0.55% and was even lower than that of maintaining the DO level at 2 mg/L. It should be emphasized that the low DO management technique only marginally decreased the sludge settleability, but had no significant impact on nutrient removal efficiency. In addition, due to the energy savings from aeration, the N₂O mitigation in this study was achieved with lower operational costs. The study emphasizes how operational enhancements can significantly contribute to the achievement of cost-effective and long-term GHG abatement results (Duan et al., 2020, pp. 6-8).

6.2. Carbon source addition

High NO₂⁻ concentrations and a low COD:N ratio are the primary factors that cause the generation of N₂O during denitrification. An adequate supply of a carbon source encourages denitrification, which increases N₂O consumption. To ensure that the denitrifiers complete denitrification without consuming internally stored chemicals, a sufficient amount of external carbon source is required. Besides, internal carbon source use has been linked to a possible increase in N₂O generation. By adding external carbon, the COD level that enters the denitrification stage can be raised. Furthermore, different types of carbon sources lead to different potential emissions because they affect the growth of denitrifiers. As a result, when

selecting an external carbon source, side emissions should be taken into account in addition to prices (Desloover et al., 2012, p. 480; Massara et al., 2017, p. 120). For example, as mentioned in chapter 3, mannitol and sodium acetate are effective carbon source in N₂O generation reduction by protecting microorganisms from NO₂⁻ accumulation and removing the antioxidant enzymes. Moreover, the COD:N ratio should be maintained at 4 for full denitrification.

The strategy of denitrification period extension is suggested and related to carbon source consumption. The rate of organic carbon in the influent will increase with adequate denitrification or period extension, resulting in more thorough denitrification and lower levels of N₂O emission. N₂O emission decreases as TN removal effectiveness increases during wastewater treatment. By modifying the operating parameters in each process, it is crucial to maximize the utilization rate of organic carbon in the influent, which can both lower TN concentration in the effluent and lower N₂O emission (Sun et al., 2015, p. 4228).

6.3. Other conditions control

This section aims at indicating some important approaches to control N₂O emissions, such as pH, temperature monitoring, magnetic powder addition, creating favorable conditions for denitrifying bacteria, inlet and NH₄⁺ concentration control, modelling and monitoring online emission.

6.3.1. pH, temperature control and magnetic field creation

As mentioned in chapter 3, pH and temperature should be monitored and controlled to maintain an optimal operating condition. Use a pH of 7 and a temperature of 20 °C for optimum performance. As a result, nitrification and denitrification can be effectively carried out with a lower accumulation of N₂O precursors and lower N₂O stripping. However, even under low-temperature conditions (4 – 15 °C), adding the right dose of magnetic powder (1 - 4 mg/L) could create magnetic fields, leading to variable degrees that enhance effluent quality. A static magnetic field influences microorganisms and water by changes to cell membranes and transport systems, electro-dynamic interactions between the magnetic force and electric currents in the living organisms, and changes in the characteristics of water (Łebkowska et al., 2018, p. 22571). The magnetic powder concurrently reduced N₂O production and emission while enhancing nutritional removal at low temperatures. N₂O conversion rate was additionally decreased by up to 76.7% at 1 mg/L of magnetic powder. The magnetic field controlled the dispersion of bacteria, altered the predominance of denitrifying functional bacteria, and

enhanced the abundance of AOB. Therefore, it has been claimed that magnetic fields are crucial in helping bacteria adapt to cold temperatures (Feng et al., 2020, pp. 5-7; Jia et al., 2018, p. 214).

6.3.2. Optimizing conditions for denitrifying bacteria

Favorable conditions for heterotrophic denitrification should be considered. If an anoxic phase is prolonged, heterotrophic denitrifiers can successfully complete all of the denitrification stages, N_2O is fully consumed and reduced to N_2 . In this sense, heterotrophic denitrification functions as a means of consuming N_2O . N_2O accumulation as an intermediate product and subsequent emission is less likely if both processes (denitrification and nitrification) are safely completed (Massara et al., 2017, p. 110). Moreover, microorganisms control is necessary for the reduction of N_2O production. Since the central ion of N_2OR enzyme contains elemental copper, its activity can be increased by passing through a portion of wastewater that contains copper ions without going over the microbial inhibitory concentration or the acceptable water quality standards. Researchers have also discovered that carbon fiber promoted the activity of denitrifying bacteria, enabling full denitrification. Consequently, controlling microbial populations and their metabolic processes can lower N_2O emissions (Lv et al., 2019, p. 3).

6.3.3. Inlet and initial ammonium concentration control

The initial ammonium is one of the key factors affecting N_2O emissions. Therefore, inlet control should be taken into account because high NH_4^+ concentration directly leads to high NO_2^- accumulation and high N_2O generation. The predecessors of N_2O , NO_2^- and NH_4^+ , can be efficiently controlled by the stepwise water inlet approach, which regulates the influent and lowers the amount of N_2O produced. In order to efficiently reduce the N_2O emissions throughout the sewage treatment process, the water entry method might be adjusted (Lv et al., 2019, p. 3).

6.3.4. Long-term monitoring

The monitoring campaigns have been divided into three different groups based on their length: short-term campaigns carried out over a brief period of time (less than one month); medium-term monitoring campaigns lasting longer than one month but not capturing all the temperature ranges observed in the system; and long-term monitoring campaigns that extend for at least a year (Vasilaki et al., 2019, p. 397). Based on the knowledge of N_2O emission pathways and

continuous online monitoring as well as accurate estimating N₂O emissions in WWTPs, strategies for N₂O generation reduction have been considered. For instance, according to emission pathways, it is suggested to place sensors at hotspots and enable them to appreciate, estimate the amount of emission, and decide whether parameters should be changed. Long-term monitoring is a method that assists operators to get data and then evaluate and control the emissions. Measuring and calculating N₂O flux during biological treatment allow timely detection of abnormalities, and sudden increases in N₂O production to have effective solutions. Therefore, it could be said that online and long-term monitoring play as an essential strategy to analyze, detect, and timely handling (Massara et al., 2017, p. 120 & 121).

In a word, it could be seen that N₂O production and emission reduction approaches are feasible and reasonable for WWTPs. These strategies are mostly based on emission pathways, boundary conditions, and current methods to estimate N₂O emissions, such as DO and aeration control, external carbon source addition, pH and temperature control, magnetic powder addition, favorable condition creation for denitrifying bacteria formation, initial ammonium control, online and long-term emission monitoring. They had been proven to show their effectiveness in N₂O production mitigation in separated studies, so once apply these methods in one wastewater treatment system, it is necessary to consider, integrate and assess the appropriation for current conditions.

CHAPTER 7: Discussion and conclusions

In this chapter, research findings in previous chapters would be discussed and evaluated, followed by the conclusions for main points related to N₂O emission pathways, mechanisms, boundary conditions, processes comparison, modelling monitoring, and approaches to reduce N₂O production.

7.1. Discussion

Because of the negative effects of N₂O, research for N₂O mitigations has been enhanced to develop. First of all, a comprehension of mechanisms and emission pathways is a decisive factor for the initial steps of reduction strategies. The analysis and comparison of several studies have been shown and demonstrated in previous chapters. Particularly, N₂O is produced during biological treatment processes related to nitrogen conversion, which is the oxidation of ammonia to nitrate by the nitrification process and the transformation of nitrate to dinitrogen gas that N₂O is an intermediate substance. When wastewater is treated, a number of microbiological reactions occur during both autotrophic and heterotrophic processes, depending on whether anoxic or aerobic conditions are present. AOB, AOA, NOB, comammox bacteria, and DNB are microorganisms involved in nitrogen cycle in biological treatment; but the contribution of AOA and comammox bacteria to N₂O emissions in wastewater is anticipated to be small. Studies indicated core enzymes of microorganisms playing essential role in nitrogen conversion: AMO and HAO in AOB participate in the oxidation of NH₃ to NO₂⁻, NO, and N₂O; NXR in NOB catalyze the conversion of NO₂⁻ to NO₃⁻; NAR, NIR, NOR, and N₂O are a chain of enzymes in DNB taking part in the reduction of NO₃⁻ to NO₃⁻, NO, N₂O, and N₂, respectively. Moreover, NH₂OH oxidation, nitrifier denitrification, and heterotrophic denitrification are the three main N₂O emission pathways. N₂O production mechanisms are the key factors in the initial steps of studying for mitigation strategies. For example, during NH₂OH oxidation, both high concentrations of DO and NO₂⁻ affect the high generation of N₂O. In contrast, nitrifier denitrification is dominant in a wide range of DO and NO₂⁻, especially with low DO levels. With the presence of oxygen during heterotrophic denitrification, microorganisms are inhibited and as a result, N₂O is the final product instead of N₂.

Balancing and combination of boundary conditions and emission pathways are crucial in the operation and control of an effective wastewater treatment plant that not only meets the effluent requirements but also reduces N₂O emissions. Besides DO and NO₂⁻ concentrations, other

parameters are also the boundary conditions that influence the formation of N_2O in biological treatment processes. For instance, initial ammonium should be controlled by equalizing the influent loading and keeping a specific flow by an equalization tank and pumps. Moreover, the C:N ratios are frequently monitored and examined to maintain at the recommended ratio of 4. Otherwise, external carbon sources would be added to supply carbon sources for bacteria. Although mannitol and sodium acetate are known to produce a lower amount of N_2O than other carbon sources, their prices and availability should be considered. Therefore, balancing C:N ratios and initial ammonium concentrations is a prerequisite that both saving fees and minimizing N_2O emissions.

Dissolved oxygen and aeration control are the most important factors. Despite the fact that DO is suggested to be maintained at 2 mg/L for efficient biological treatment and N_2O emission reduction, in a full-scale wastewater treatment plant, DO and N_2O concentrations should be long-term monitored together. A sufficient DO concentration lead to the efficiency in nitrification, denitrification, and minimizing N_2O emission as well. Because the nitrifier denitrification is enhanced under low DO conditions and the formation of N_2O through the NH_2OH oxidation pathway is primary under high DO concentrations. In other words, a low DO level in the nitrification tank causes a local oxygen restriction and accelerates the production of N_2O . Aeration rates that are too high introduce more oxygen to the denitrification tank, which can encourage N_2O emissions due to the inhibition of bacteria, particularly N_2OR . On the other hand, the method of maintaining DO concentration at 0.5 mg/L, which permits the simultaneous occurrence of nitrification and denitrification, had been developed and successfully tested in a full-scale SBR with long-term monitoring. Even lower than keeping the DO level at 2 mg/L, the N_2O emission rate decreased, assisting energy saving for aeration. The emission of N_2O to the atmosphere is also related to aeration due to the high gas mass transfer coefficient. NO_2^- accumulation is a consequence of insufficient and unstable aeration control, which results in higher N_2O generation. Retention time should be noticed to avoid incomplete denitrification as well as continuously transient aerobic-anoxic conditions. Besides, DO monitoring is usually combined with pH and temperature measurements. Utilizing a pH of 7 and a temperature of 20°C for optimum performance is suggested. Furthermore, in case of low temperature, creating magnetic fields with magnetic powder (1 - 4 mg/L) was considered to enhance nutrient removal and reduce N_2O formation. The alterations of temperatures influence the results of N_2O emission recorded during monitoring process in winter (14°C) and

summer (22.5°C), revealing EFs in winter are higher than EFs in summer campaigns (Vasilaki et al., 2019, p. 398), indicated that adjusting and balancing water temperatures are necessary for N₂O reduction. As a result, it could be said that a combination of boundary conditions with monitoring parameters is considered as a long-term strategy. The alterations of parameters manifest through the concentrations of N₂O production recorded by sensors.

The N₂O emissions could be evaluate short-term or long-term, grab sampling or online monitoring, but short-term programs provide unreliable EFs estimations and underestimating actual emissions. The most reliable and precise estimate of the annual nitrous oxide emission from the WWTPs is provided by long-term weekly grab samples, but this sampling approach is not representative for the whole measurement period. Since many operational characteristics of a WWTP also exhibit diurnal variations, diurnal patterns may be particularly useful for research purposes to discover the processes behind the N₂O emission (DO, nitrogen load, influent flow etc.). The debate over which process parameters cause N₂O emissions requires understanding of both the short-term dynamics of the N₂O emission and the process conditions. The short-term dynamics of the N₂O emission can only be determined by high-frequency-online sampling, as the current work shows. Therefore, long-term monitoring is a technique that helps operators collect data, assess it, and then decide how to manage emissions as well as develop operational strategies. Long-term and online monitoring is a crucial technique for analysis, detection, prompt handling, and focus on less production but subsequently its consumption. A method to determine the number of grab samples or online sampling periods is necessary to produce a suitably accurate assessment of the emission was offered as a guideline to help balance cost and precision (Daelman et al., 2013, pp. 3124 - 3129).

Indeed, the integration of boundary conditions and long-term monitoring strategies should be proposed to reduce N₂O emissions. These two factors are interdependent and complementary. N₂O reduction campaigns base on EFs to evaluate, adjust operation parameters, and develop minimizing approaches. However, there is no ideal or standardized method for every WWTPs, the choices depend on empirical data and pathways assessments. Furthermore, only focusing on N₂O reduction is not feasible for real full-scale WWTPs, but it always requires system performance and energy consumption optimization. It is recommended that future studies should combine N₂O control strategies into operational conditions to reduce the carbon footprint in WWTPs (Vasilaki et al., 2019, p. 408). Besides the CAS process, other processes that save space and energy such as nitrification-denitrification, biofilm, and AGS should be

considered to find optimal conditions in N₂O reduction. Particularly, as mentioned in chapter 4, although N₂O emission in suspended-growth systems is lower than that of biofilm systems, in other research, N₂O emissions showed an inverse exponential relationship with biofilm thickness, which means N₂O emissions dropped as biofilm thickness rose due to the retention of denitrifiers with slow growth rates and the low diffusivity of N₂O (Eldyasti et al., 2014, p. 281 & 288). This result implies that further research could invest in various biofilm thicknesses, especially thicker biofilms.

7.2. Conclusions

Microorganisms significantly contribute to N₂O production during biological treatment. In particular, AOB play an important role in nitrogen cycle. AOB use ammonia as their only supply and catalyze the conversion of NH₃ to NO₂⁻ via NH₂OH, which is the first step in nitrification. They also fix CO₂ to provide carbon for biosynthesis. Ammonia oxidation by AOB requires the key enzymes HAO and AMO. N₂O was released in significant amounts when the environment was aerated with ammonium NH₄⁺ or NH₂OH. NOB compensates for nitrogen loss by converting nitrite to nitrate, which is used as a nitrogen source by several microbes and plants. As a result, NOB are essential regulators of the nitrogen cycle. The key enzyme of NOB, NXR, catalyzes the transformation of nitrite into nitrate. If nitrite from WWTPs penetrates into freshwater sources, the ineffectiveness of nitrite oxidation could have a negative impact on the ecosystem. DNB participate in the denitrification process. As part of the denitrification process, NO₃⁻ and NO₂⁻ are reduced to produce NO, N₂O, and ultimately N₂. The four enzymes involved are nitrate reductase, nitrite reductase, nitric oxide reductase, and nitrous oxide reductase. During wastewater denitrification processes, inhibition of the nitrous oxide reductase enzyme frequently produces N₂O. Although AOA are known to join in N₂O production, the mechanisms underlying AOA are still poorly known. Besides, Comammox bacteria enrichments were obtained in the lab in ammonia-limiting conditions because Comammox bacteria are thought to have a competitive advantage over conventional ammonia oxidizers such as AOB. Comammox *Nitrospira* have genomes for NH₃ and NO₂⁻ oxidation, which resemble the traditional AOB and NOB, respectively, in terms of structure, but the identification of their ability to form N₂O is limited. To learn more about the potential function of Comammox bacteria in N₂O production, researchers are currently looking into whether it is present in wastewater treatment procedures.

Nitrifier denitrification, NH_2OH oxidation, and heterotrophic denitrification are the three biological processes that produce N_2O . When NO_2^- is reduced by AOB with ammonia, hydrogen, or pyruvate as electron donors, such as when there is little oxygen present or there is a high concentration of nitrite, this process is known as nitrifier denitrification. The unbalanced metabolism of AOB is thought to be related to NH_2OH oxidation, which produces N_2O and NO but not N_2 from biological hydroxylamine oxidation intermediates like $\text{N}_2\text{O}_2\text{H}_2$ and HNO . The process of heterotrophic denitrification occurs when nitrogen-reducing enzymes produce N_2O as a result of imbalanced activity circumstances, such as NO_2^- accumulation, oxygen inhibition, or a lack of biodegradable organic molecules. It was established that nitrification was the main process involved in the generation and emission of N_2O . Aerated phases are where gaseous N_2O emits to the environment most frequently because of the extremely high gas mass transfer coefficient. The NH_2OH oxidation process is predominant create N_2O in aerobic environments. However, as DO concentrations decrease, high NO_2^- levels are present, and there is likely nitrogen overload in the system, which accelerates the rate of N_2O formation, and the nitrifier denitrification route becomes more important.

Numerous processes contribute to N_2O emissions in WWTPs, and these emissions vary greatly depending on the nitrogen load, the characteristics of the influent, the operational and environmental circumstances. An excessive initial ammonium loading results in an accumulation of NH_2OH and is reduced to N_2O . Daily maximum loadings were also when N_2O emissions peaked. During nitrification, DO is thought to be a crucial component regulating N_2O release. The N_2O fluxes were low and had a fairly steady level when the DO content was higher than 2 mg/L. NO_2^- has a substantial effect on the production of N_2O . It has been shown that elevated NO_2^- concentrations promote nitrifier denitrification by upregulating the *nirK* gene. The presence and composition of carbon sources have an effect on N_2O formation. By lowering the N_2OR enzyme inhibition brought on by the high NO_2^- concentration in the partial nitrification system, mannitol enhanced the completion of heterotrophic denitrification. Full denitrification requires a C:N ratio higher than 4. However, as diverse metabolic pathways utilize varied carbon sources, this could not apply to all types of carbon sources. Furthermore, because it takes time for the metabolism of bacteria to adjust to changes in their environment, the tendency of nitrifying cultures to produce N_2O is driven by a rapid change from anoxic to aerobic conditions, which results in substantial peak N_2O emissions. A temperature of approximately 20°C and a pH controlled at about 7 are the factors that ensure the end of

nitrification. At high phosphorus concentrations, which favor denitrification, a large abundance of DPAOs was discovered. For the development of microorganisms, the COD:N:P ratio should be 100:5:1.

Different methods of wastewater treatment result in various levels of N₂O emissions. Particularly, in comparison of suspended-growth system and attached-growth system, nitrification/denitrification and nitrification/denitrification, CAS and AGS, although biofilm system, nitrification/denitrification, and AGS show their advantages in saving space, oxygen, and energy consumption, N₂O emission from these processes is higher than that in CAS system.

Numerous methods have been developed to measure and calculate N₂O emissions in WWTPs. Based on capita protein consumption to calculate N₂O emitted, the IPCC approach is the global standard and the most widely used empirical technique for measuring N₂O emission in WWTPs. More recent on-site observations of N₂O emissions at WWTPs have superseded theoretical methods for the N₂O calculation. Reliable N₂O monitoring assist the discovery of improved process control techniques to lower N₂O emissions from WWTPs. In general, a floating chamber is utilized to capture the N₂O emitted from activated sludge tanks in order to quantify N₂O emission in gas-phase. On the other hand, since N₂O is produced in the liquid phase, measuring the concentration of dissolved N₂O would probably offer more information about the processes that produce N₂O, opening up more opportunities for prevention and control. Grab sampling-gas chromatography analysis, the stripping method, or using a Clark-type electrode are the two most used ways to measure the concentration of dissolved N₂O.

Acknowledging the fundamental elements that influence N₂O emissions is crucial since it enables the development of effective mitigation strategies. As a result, summarization and recommendations are proposed to reduce N₂O generation and emission based on the findings. During nitrification and denitrification, DO must be regulated and kept at a sufficient concentration. Normally, DO should be maintained at a level of 2 mg/L for nitrification to be completed. A substantial amount of an external carbon source is needed to guarantee that the denitrifiers finish denitrification without consuming any of the compounds they have stored internally. Operation at a pH of 7 at a temperature of 20°C is suggested. However, even at low temperatures (4-15°C), adding the proper amount of magnetic powder (1-4 mg/L) could produce magnetic fields with varying intensities that improve effluent quality and reduce N₂O formation. Furthermore, reducing the generation of N₂O requires the control of microbes.

Wastewater entry technique may need to be changed and inlet control should be considered. An important technique for analysis, detection, and prompt handling is long-term and online monitoring. The decisions are based on empirical data and assessments of the approaches; there is no perfect or uniform procedure for all WWTPs. The management and control of an efficient wastewater treatment plant that not only meets the effluent criteria but also lowers N₂O emissions depends on the balancing and combination of these variables. Therefore, when using these techniques in a single wastewater treatment system, it is important to take into account, integrate, and evaluate the appropriateness for the present term.



Vietnamese-German University

SUMMARY

The thesis provides a general and comprehensive view of N₂O emissions during biological treatment in WWTPs based on previous literature reviews. Thereby, the problems posed by N₂O emissions have been solved:

- N₂O is generated mostly from biological treatment with the catalyst of microorganisms: AOB, NOB, DNB, AOA, and comammox bacteria and their enzymes: AMO, HAO, NXR, NIR, NAR, NOR, and N₂OR.
- The three main pathways of N₂O production are: NH₂OH oxidation, nitrifier denitrification, and heterotrophic denitrification which the dominant pathway depends on the DO and NO₂⁻ conditions.
- Different boundary conditions: Initial ammonium, DO, NO₂⁻ concentration, carbon sources, transient anoxic-aerobic conditions, pH, temperature, and phosphorus concentrations have been taken into consideration.
- Various wastewater treatment processes: suspended-growth system and attached growth system, nitrification/denitrification and nitrification/denitrification, CAS and AGS have been compared in terms of N₂O production
- Through current research on N₂O calculation models, the methods of N₂O estimation based on capita protein consumption, direct measuring methods including off-gas measuring and dissolved gas measuring have been introduced and showed the procedure and calculation steps.
- According to the above mentioned sections, approaches to prevent and mitigate N₂O emission have been proposed and the point of balancing these parameters is also discussed.

BIBLIOGRAPHY

- [1] Aboobakar, A., Cartmell, E., Stephenson, T., Jones, M., Vale, P., & Dotro, G. (2013). Nitrous oxide emissions and dissolved oxygen profiling in a full-scale nitrifying activated sludge treatment plant. *Water Research*, 47(2), 524-534. <https://doi.org/10.1016/j.watres.2012.10.004>
- [2] Adouani, N., Limousy, L., Lendormi, T., & Sire, O. (2015). N₂O and NO emissions during wastewater denitrification step: influence of temperature on the biological process. *Comptes Rendus Chimie*, 18(1), 15-22. <https://doi.org/10.1016/j.crci.2014.11.005>
- [3] Ahn, J. H., Kim, S., Park, H., Rahm, B., Pagilla, K., & Chandran, K. (2010). N₂O emissions from activated sludge processes, 2008– 2009: results of a national monitoring survey in the United States. *Environmental Science & Technology*, 44(12), 4505-4511. <http://dx.doi.org/10.1021/es903845y>
- [4] Ahn, J. H., Kwan, T., & Chandran, K. (2011). Comparison of partial and full nitrification processes applied for treating high-strength nitrogen wastewaters: microbial ecology through nitrous oxide production. *Environmental Science & Technology*, 45(7), 2734-2740. <https://doi.org/10.1021/es103534g>
- [5] Anderson, I. C., Poth, M., Homstead, J., & Burdige, D. (1993). A comparison of NO and N₂O production by the autotrophic nitrifier *Nitrosomonas europaea* and the heterotrophic nitrifier *Alcaligenes faecalis*. *Applied and environmental microbiology*, 59(11), 3525-3533. <https://doi.org/10.1128/aem.59.11.3525-3533.1993>
- [6] Arp, D. J., Chain, P. S., & Klotz, M. G. (2007). The impact of genome analyses on our understanding of ammonia-oxidizing bacteria. *Annual review of microbiology*, 61(1), 503-528. <https://doi.org/10.1146/annurev.micro.61.080706.093449>
- [7] Baresel, C., Andersson, S., Yang, J., & Andersen, M. H. (2016). Comparison of nitrous oxide (N₂O) emissions calculations at a Swedish wastewater treatment plant based on water concentrations versus off-gas concentrations. *Advances in Climate Change Research*, 7(3), 185-191. <http://dx.doi.org/10.1016/j.accre.2016.09.001>
- [8] Bassin, J., Kleerebezem, R., Dezotti, M., & Van Loosdrecht, M. (2012). Simultaneous nitrogen and phosphate removal in aerobic granular sludge reactors operated at different temperatures. *Water Research*, 46(12), 3805-3816. <http://dx.doi.org/10.1016/j.watres.2012.04.015>

-
- [9] Beaumont, H. J., Lens, S. I., Reijnders, W. N., Westerhoff, H. V., & Van Spanning, R. J. (2004). Expression of nitrite reductase in *Nitrosomonas europaea* involves NsrR, a novel nitrite-sensitive transcription repressor. *Molecular microbiology*, 54(1), 148-158. <https://doi.org/10.1111/j.1365-2958.2004.04248.x>
- [10] Caranto, J. D., Vilbert, A. C., & Lancaster, K. M. (2016). *Nitrosomonas europaea* cytochrome P460 is a direct link between nitrification and nitrous oxide emission. *Proceedings of the National Academy of Sciences*, 113(51), 14704-14709. <https://doi.org/10.1073/pnas.161105111>
- [11] Castro-Barros, C. M., Daelman, M., Mampaey, K., Van Loosdrecht, M., & Volcke, E. (2015). Effect of aeration regime on N₂O emission from partial nitrification-anammox in a full-scale granular sludge reactor. *Water Research*, 68, 793-803. <http://dx.doi.org/10.1016/j.watres.2014.10.056>
- [12] Chandran, K., Stein, L. Y., Klotz, M. G., & van Loosdrecht, M. C. (2011). Nitrous oxide production by lithotrophic ammonia-oxidizing bacteria and implications for engineered nitrogen-removal systems. *Biochemical Society Transactions*, 39(6), 1832-1837. <https://doi.org/10.1042/BST20110717>
- [13] Daelman, M. R., De Baets, B., van Loosdrecht, M. C., & Volcke, E. I. (2013). Influence of sampling strategies on the estimated nitrous oxide emission from wastewater treatment plants. *Water Research*, 47(9), 3120-3130. <https://doi.org/10.1016/j.watres.2013.03.016>
- [14] Daims, H., Lebedeva, E. V., Pjevac, P., Han, P., Herbold, C., Albertsen, M., Jehmlich, N., Palatinszky, M., Vierheilig, J., & Bulaev, A. (2015). Complete nitrification by *Nitrospira* bacteria. *Nature*, 528(7583), 504-509. <https://doi.org/10.1038/nature16461>
- [15] Daims, H., Lücker, S., & Wagner, M. (2016). A new perspective on microbes formerly known as nitrite-oxidizing bacteria. *Trends in microbiology*, 24(9), 699-712. <https://doi.org/10.1016/j.tim.2016.05.004>
- [16] Das, S. (2011). Estimation of greenhouse gases emissions from biological wastewater treatment plants at Windsor. Retrieved from <https://scholar.uwindsor.ca/etd/77>.
- [17] Daudt, G. C., Xavier, J. A., Meotti, B., Guimarães, L. B., & da Costa, R. H. (2019). Researching new ways to reduce N₂O emission from a granular sludge sequencing batch reactor treating domestic wastewater under subtropical climate conditions. *Brazilian Journal of Chemical Engineering*, 36, 209-220. [dx.doi.org/10.1590/0104-6632.20190361s20170566](https://doi.org/10.1590/0104-6632.20190361s20170566)

-
- [18] de Haas, D., & Andrews, J. (2022). Nitrous Oxide Emissions from Wastewater Treatment- Revisiting the Ipcc 2019 Refinement Guidelines. *Environmental Challenges*, <https://doi.org/10.1016/j.envc.2022.100557>, 100557.
- [19] Desloover, J., Vlaeminck, S. E., Clauwaert, P., Verstraete, W., & Boon, N. (2012). Strategies to mitigate N₂O emissions from biological nitrogen removal systems. *Current Opinion in Biotechnology*, 23(3), 474-482. <https://doi.org/10.1016/j.copbio.2011.12.030>
- [20] Duan, H., van den Akker, B., Thwaites, B. J., Peng, L., Herman, C., Pan, Y., Ni, B.-J., Watt, S., Yuan, Z., & Ye, L. (2020). Mitigating nitrous oxide emissions at a full-scale wastewater treatment plant. *Water Research*, 185, 116196. <https://doi.org/10.1016/j.watres.2020.116196>
- [21] Dworkin, M., & Gutnick, D. (2012). Sergei Winogradsky: a founder of modern microbiology and the first microbial ecologist. *FEMS microbiology reviews*, 36(2), 364-379. <https://doi.org/10.1111/j.1574-6976.2011.00299.x>
- [22] Eldyasti, A., Nakhla, G., & Zhu, J. (2014). Influence of biofilm thickness on nitrous oxide (N₂O) emissions from denitrifying fluidized bed bioreactors (DFBBRs). *Journal of Biotechnology*, 192, 281-290. <http://dx.doi.org/10.1016/j.jbiotec.2014.10.008>
- [23] Environment, U. (Producer) (2022). Nitrous Oxide Process Emissions – From Research to Application. Retrieved from <https://unisense-environment.com/events/webinar-nitrous-oxide-process-emissions-from-research-to-application/>
- [24] EPA, U. S. E. P. A. (2007). *Wastewater Management Fact Sheet - Denitrifying Filters*. Office of Water.
- [25] Feng, C., Li, Z., Zhu, Y., Xu, D., Geng, J., Ren, H., & Xu, K. (2020). Effect of magnetic powder on nitrous oxide emissions from a sequencing batch reactor for treating domestic wastewater at low temperatures. *Bioresource Technology*, 315, 123848. <https://doi.org/10.1016/j.biortech.2020.123848>
- [26] Foley, J., De Haas, D., Yuan, Z., & Lant, P. (2010). Nitrous oxide generation in full-scale biological nutrient removal wastewater treatment plants. *Water Research*, 44(3), 831-844. <https://doi.org/10.1016/j.watres.2009.10.033>
- [27] Frankel, T. (2022). Moving bed biofilm reactor (MBBR) vs. conventional activated sludge system (CAS). Retrieved from <https://www.ssaeration.com/mbbr-vs-cas/>
- [28] Frison, N., Chiumenti, A., Katsou, E., Malamis, S., Bolzonella, D., & Fatone, F. (2015). Mitigating off-gas emissions in the biological nitrogen removal via nitrite process

- treating anaerobic effluents. *Journal of Cleaner Production*, 93, 126-133. <http://dx.doi.org/10.1016/j.jclepro.2015.01.017>
- [29] Guo, G., Wang, Y., Hao, T., Wu, D., & Chen, G.-H. (2018). Enzymatic nitrous oxide emissions from wastewater treatment. *Frontiers of Environmental Science & Engineering*, 12(1), 1-12. <https://doi.org/10.1007/s11783-018-1021-3>
- [30] Gustavsson, D., Syd, V., & Malmö, S. (2010). Biological sludge liquor treatment at municipal wastewater treatment plants—a review. *Vatten*, 66(3), 179-192.
- [31] Holmes, D. E., Dang, Y., & Smith, J. A. (2019). Nitrogen cycling during wastewater treatment. *Advances in applied microbiology*, 106, 113-192. <https://doi.org/10.1016/bs.aambs.2018.10.003>
- [32] Holtan-Hartwig, L., Dörsch, P., & Bakken, L. R. (2000). Comparison of denitrifying communities in organic soils: kinetics of NO₃⁻ and N₂O reduction. *Soil biology and Biochemistry*, 32(6), 833-843. [http://dx.doi.org/10.1016/S0038-0717\(99\)00213-8](http://dx.doi.org/10.1016/S0038-0717(99)00213-8)
- [33] Hu, Z., Zhang, J., Li, S., & Xie, H. (2013). Impact of carbon source on nitrous oxide emission from anoxic/oxic biological nitrogen removal process and identification of its emission sources. *Environmental Science and Pollution Research*, 20(2), 1059-1069. <https://doi.org/10.1007/s11356-012-1018-6>
- [34] Hynes, R. K., & Knowles, R. (1984). Production of nitrous oxide by *Nitrosomonas europaea*: effects of acetylene, pH, and oxygen. *Canadian Journal of Microbiology*, 30(11), 1397-1404. <https://doi.org/10.1139/m84-222>
- [35] Igarashi, N., Moriyama, H., Fujiwara, T., Fukumori, Y., & Tanaka, N. (1997). The 2.8 Å structure of hydroxylamine oxidoreductase from a nitrifying chemoautotrophic bacterium, *Nitrosomonas europaea*. *Nature structural biology*, 4(4), 276-284. <http://dx.doi.org/10.1038/nsb0497-276>
- [36] IPCC. (2019). *2019 Refinement to the 2006 IPCC guidelines for national greenhouse gas inventories*. Switzerland: Institute for Global Environmental Strategies Hayama Retrieved from <https://www.ipcc.ch/report/2019-refinement-to-the-2006-ipcc-guidelines-for-national-greenhouse-gas-inventories/>.
- [37] Itokawa, H., Hanaki, K., & Matsuo, T. (2001). Nitrous oxide production in high-loading biological nitrogen removal process under low COD/N ratio condition. *Water Research*, 35(3), 657-664. [http://doi.org/10.1016/s0043-1354\(00\)00309-2](http://doi.org/10.1016/s0043-1354(00)00309-2)

-
- [38] Jahn, L., Svardal, K., & Krampe, J. (2019). Nitrous oxide emissions from aerobic granular sludge. *Water Science and Technology*, 80(7), 1304-1314. <https://doi.org/10.2166/wst.2019.378>
- [39] Jia, W., Zhang, J., Lu, Y., Li, G., Yang, W., & Wang, Q. (2018). Response of nitrite accumulation and microbial characteristics to low-intensity static magnetic field during partial nitrification. *Bioresource Technology*, 259, 214-220. <https://doi.org/10.1016/j.biortech.2018.03.060>
- [40] Kampschreur, M. J., Temmink, H., Kleerebezem, R., Jetten, M. S., & van Loosdrecht, M. C. (2009). Nitrous oxide emission during wastewater treatment. *Water Research*, 43(17), 4093-4103. <https://doi.org/10.1016/j.watres.2009.03.001>
- [41] Kampschreur, M. J., van der Star, W. R., Wielders, H. A., Mulder, J. W., Jetten, M. S., & van Loosdrecht, M. C. (2008). Dynamics of nitric oxide and nitrous oxide emission during full-scale reject water treatment. *Water Research*, 42(3), 812-826. <http://dx.doi.org/10.1016/j.watres.2007.08.022>
- [42] Kanders, L., Yang, J.-J., Baresel, C., & Zambrano, J. (2019). Full-scale comparison of N₂O emissions from SBR N/DN operation versus one-stage deammonification MBBR treating reject water and optimization with pH set-point. *Water Science and Technology*, 79(8), 1616-1625. <https://doi.org/10.2166/wst.2019.163>
- [43] Kartal, B., Kuypers, M. M., Lavik, G., Schalk, J., Op den Camp, H. J., Jetten, M. S., & Strous, M. (2007). Anammox bacteria disguised as denitrifiers: nitrate reduction to dinitrogen gas via nitrite and ammonium. *Environmental microbiology*, 9(3), 635-642. <https://doi.org/10.1111/j.1462-2920.2006.01183.x>
- [44] Kim, S.-W., Miyahara, M., Fushinobu, S., Wakagi, T., & Shoun, H. (2010). Nitrous oxide emission from nitrifying activated sludge dependent on denitrification by ammonia-oxidizing bacteria. *Bioresource Technology*, 101(11), 3958-3963. <https://doi.org/10.1016/j.biortech.2010.01.030>
- [45] Könneke, M., Bernhard, A. E., de La Torre, J. R., Walker, C. B., Waterbury, J. B., & Stahl, D. A. (2005). Isolation of an autotrophic ammonia-oxidizing marine archaeon. *Nature*, 437(7058), 543-546. <https://doi.org/10.1038/nature03911>
- [46] Law, Y., Lant, P., & Yuan, Z. (2011). The effect of pH on N₂O production under aerobic conditions in a partial nitrification system. *Water Research*, 45(18), 5934-5944. <https://doi.org/10.1016/j.watres.2011.08.055>

-
- [47] Law, Y., Lant, P., & Yuan, Z. (2013). The confounding effect of nitrite on N₂O production by an enriched ammonia-oxidizing culture. *Environmental Science & Technology*, 47(13), 7186-7194. <https://doi.org/10.1021/es4009689>
- [48] Law, Y., Ni, B.-J., Lant, P., & Yuan, Z. (2012a). N₂O production rate of an enriched ammonia-oxidising bacteria culture exponentially correlates to its ammonia oxidation rate. *Water Research*, 46(10), 3409-3419. <https://doi.org/10.1016/j.watres.2012.03.043>
- [49] Law, Y., Ye, L., Pan, Y., & Yuan, Z. (2012b). Nitrous oxide emissions from wastewater treatment processes. *Philosophical Transactions of the Royal Society B: Biological Sciences*, 367(1593), 1265-1277. <https://doi.org/10.1098/rstb.2011.0317>
- [50] Łebkowska, M., Rutkowska-Narożniak, A., Pajor, E., Tabernacka, A., & Załęska-Radziwiłł, M. (2018). Impact of a static magnetic field on biodegradation of wastewater compounds and bacteria recombination. *Environmental Science and Pollution Research*, 25(23), 22571-22583. <https://doi.org/10.1007/s11356-018-1943-0>
- [51] Lewis Jr, W. M., & Morris, D. P. (1986). Toxicity of nitrite to fish: a review. *Transactions of the American fisheries society*, 115(2), 183-195. [https://doi.org/10.1577/1548-8659\(1986\)115<183:TOXNIT>2.0.CO;2](https://doi.org/10.1577/1548-8659(1986)115<183:TOXNIT>2.0.CO;2)
- [52] Li, P., Wang, S., Peng, Y., Liu, Y., & He, J. (2015). The synergistic effects of dissolved oxygen and pH on N₂O production in biological domestic wastewater treatment under nitrifying conditions. *Environmental technology*, 36(13), 1623-1631. <http://dx.doi.org/10.1080/09593330.2014.1002862>
- [53] Liu, Y., & Liu, Q.-S. (2006). Causes and control of filamentous growth in aerobic granular sludge sequencing batch reactors. *Biotechnology Advances*, 24(1), 115-127. <https://doi.org/10.1016/j.biotechadv.2005.08.001>
- [54] Lv, Y., Zhang, S., Yang, Y., Liu, Y., Xie, K., & Zhong, J. (2019). N₂O emission and control strategy in different wastewater treatment processes. Paper presented at the E3S Web of Conferences. <https://doi.org/10.1051/e3sconf/201911804029>
- [55] Maktabifard, M., Blomberg, K., Zaborowska, E., Mikola, A., & Mąkinia, J. (2022). Model-based identification of the dominant N₂O emission pathway in a full-scale activated sludge system. *Journal of Cleaner Production*, 336, 130347. <https://doi.org/10.1016/j.jclepro.2021.130347>

-
- [56] Mampaey, K. E., van Dongen, U. G., van Loosdrecht, M. C., & Volcke, E. I. (2015). Novel method for online monitoring of dissolved N₂O concentrations through a gas stripping device. *Environmental technology*, 36(13), 1680-1690. <http://dx.doi.org/10.1080/09593330.2015.1005029>
- [57] Massara, T. M., Malamis, S., Guisasola, A., Baeza, J. A., Noutsopoulos, C., & Katsou, E. (2017). A review on nitrous oxide (N₂O) emissions during biological nutrient removal from municipal wastewater and sludge reject water. *Science of the Total Environment*, 596, 106-123. <http://dx.doi.org/10.1016/j.scitotenv.2017.03.191>
- [58] Mello, W. Z. d., Ribeiro, R. P., Brotto, A. C., Kligerman, D. C., Piccoli, A. d. S., & Oliveira, J. L. (2013). Nitrous oxide emissions from an intermittent aeration activated sludge system of an urban wastewater treatment plant. *Química Nova*, 36, 16-20. <http://dx.doi.org/10.1590/S0100-40422013000100004>
- [59] Mino, T., Van Loosdrecht, M., & Heijnen, J. (1998). Microbiology and biochemistry of the enhanced biological phosphate removal process. *Water Research*, 32(11), 3193-3207. [https://doi.org/10.1016/S0043-1354\(98\)00129-8](https://doi.org/10.1016/S0043-1354(98)00129-8)
- [60] Myers, S., Mikola, A., Blomberg, K., Kuokkanen, A., & Rosso, D. (2021). Comparison of methods for nitrous oxide emission estimation in full-scale activated sludge. *Water Science and Technology*, 83(3), 641-651. <https://doi.org/10.2166/wst.2021.033>
- [61] Nancharaiah, Y. V., & Sarvajith, M. (2019). Aerobic granular sludge process: a fast growing biological treatment for sustainable wastewater treatment. *Current Opinion in Environmental Science & Health*, 12, 57-65. <https://doi.org/10.1016/j.coesh.2019.09.011>
- [62] Ni, B.-J., Peng, L., Law, Y., Guo, J., & Yuan, Z. (2014). Modeling of nitrous oxide production by autotrophic ammonia-oxidizing bacteria with multiple production pathways. *Environmental Science & Technology*, 48(7), 3916-3924. <https://doi.org/10.1021/es405592h>
- [63] Ni, B.-J., Ye, L., Law, Y., Byers, C., & Yuan, Z. (2013). Mathematical modeling of nitrous oxide (N₂O) emissions from full-scale wastewater treatment plants. *Environmental Science & Technology*, 47(14), 7795-7803. <https://doi.org/10.1021/es4005398>
- [64] Ni, B.-J., & Yuan, Z. (2015). Recent advances in mathematical modeling of nitrous oxides emissions from wastewater treatment processes. *Water Research*, 87, 336-346. <https://doi.org/10.1016/j.watres.2015.09.049>

-
- [65] Otte, S., Grobden, N. G., Robertson, L. A., Jetten, M., & Kuenen, J. G. (1996). Nitrous oxide production by *Alcaligenes faecalis* under transient and dynamic aerobic and anaerobic conditions. *Applied and environmental microbiology*, 62(7), 2421-2426. <https://doi.org/10.1128/aem.62.7.2421-2426.1996>
- [66] Palomo, A., Pedersen, A. G., Fowler, S. J., Dechesne, A., Sicheritz-Pontén, T., & Smets, B. F. (2018). Comparative genomics sheds light on niche differentiation and the evolutionary history of comammox Nitrospira. *The ISME journal*, 12(7), 1779-1793. <https://doi.org/10.1038/s41396-018-0083-3>
- [67] Peng, L., Ni, B.-J., Eler, D., Ye, L., & Yuan, Z. (2014). The effect of dissolved oxygen on N₂O production by ammonia-oxidizing bacteria in an enriched nitrifying sludge. *Water Research*, 66, 12-21. <http://dx.doi.org/10.1016/j.watres.2014.08.009>
- [68] Peng, L., Ni, B.-J., Ye, L., & Yuan, Z. (2015). The combined effect of dissolved oxygen and nitrite on N₂O production by ammonia oxidizing bacteria in an enriched nitrifying sludge. *Water Research*, 73, 29-36. <http://dx.doi.org/10.1016/j.watres.2015.01.021>
- [69] Poh, L. S., Jiang, X., Zhang, Z., Liu, Y., Ng, W. J., & Zhou, Y. (2015). N₂O accumulation from denitrification under different temperatures. *Applied microbiology and biotechnology*, 99(21), 9215-9226. <http://dx.doi.org/10.1007/s00253-015-6742-7>
- [70] Poth, M., & Focht, D. D. (1985). ¹⁵N kinetic analysis of N₂O production by *Nitrosomonas europaea*: an examination of nitrifier denitrification. *Applied and environmental microbiology*, 49(5), 1134-1141. <http://doi.org/10.1128/aem.49.5.1134-1141.1985>
- [71] Poughon, L., Dussap, C. G., & Gros, J. B. (2001). Energy model and metabolic flux analysis for autotrophic nitrifiers. *Biotechnology and Bioengineering*, 72(4), 416-433. [https://doi.org/10.1002/1097-0290\(20000220\)72:4<416::AID-BIT1004>3.0.CO;2-D](https://doi.org/10.1002/1097-0290(20000220)72:4<416::AID-BIT1004>3.0.CO;2-D)
- [72] Ramírez-Melgarejo, M., Reyes-Figueroa, A., Gassó-Domingo, S., & Güereca, L. P. (2020). Analysis of empirical methods for the quantification of N₂O emissions in wastewater treatment plants: comparison of emission results obtained from the IPCC Tier 1 methodology and the methodologies that integrate operational data. *Science of the Total Environment*, 747, 141288. <https://doi.org/10.1016/j.scitotenv.2020.141288>
- [73] Rassamee, V., Sattayatewa, C., Pagilla, K., & Chandran, K. (2011). Effect of oxic and anoxic conditions on nitrous oxide emissions from nitrification and denitrification processes. *Biotechnology and Bioengineering*, 108(9), 2036-2045. <https://doi.org/10.1002/bit.23147>

-
- [74] Ray, S., Mohanty, A., Mohanty, S., Mishra, S., & Chaudhury, G. R. (2014). Removal of nitrate and COD from wastewater using denitrification process: kinetic, optimization, and statistical studies. *Clean Technologies and Environmental Policy*, 16(2), 291-301. <https://doi.org/10.1007/s10098-013-0621-7>
- [75] Ribera-Guardia, A., Marques, R., Arangio, C., Carvalheira, M., Oehmen, A., & Pijuan, M. (2016). Distinctive denitrifying capabilities lead to differences in N₂O production by denitrifying polyphosphate accumulating organisms and denitrifying glycogen accumulating organisms. *Bioresource Technology*, 219, 106-113. <http://dx.doi.org/10.1016/j.biortech.2016.07.092>
- [76] Rodríguez-Caballero, A., Aymerich, I., Marques, R., Poch, M., & Pijuan, M. (2015). Minimizing N₂O emissions and carbon footprint on a full-scale activated sludge sequencing batch reactor. *Water Research*, 71, 1-10. <http://dx.doi.org/10.1016/j.watres.2014.12.032>
- [77] Sabba, F., Picioreanu, C., Boltz, J. P., & Nerenberg, R. (2017a). Predicting N₂O emissions from nitrifying and denitrifying biofilms: a modeling study. *Water Science and Technology*, 75(3), 530-538. <https://doi.org/10.2166/wst.2016.484>
- [78] Sabba, F., Picioreanu, C., & Nerenberg, R. (2017b). Mechanisms of nitrous oxide (N₂O) formation and reduction in denitrifying biofilms. *Biotechnology and Bioengineering*, 114(12), 2753-2761. <https://doi.org/10.1002/bit.26399>
- [79] Sabba, F., Picioreanu, C., Pérez, J., & Nerenberg, R. (2015). Hydroxylamine diffusion can enhance N₂O emissions in nitrifying biofilms: a modeling study. *Environmental Science & Technology*, 49(3), 1486-1494. <https://doi.org/10.1021/es5046919>
- [80] Sabba, F., Terada, A., Wells, G., Smets, B. F., & Nerenberg, R. (2018). Nitrous oxide emissions from biofilm processes for wastewater treatment. *Applied microbiology and biotechnology*, 102(22), 9815-9829. <https://doi.org/10.1007/s00253-018-9332-7>
- [81] Santoro, A. E., Buchwald, C., McIlvin, M. R., & Casciotti, K. L. (2011). Isotopic signature of N₂O produced by marine ammonia-oxidizing archaea. *Science*, 333(6047), 1282-1285. <https://doi.org/10.1126/science.1208239>
- [82] Schalk-Otte, S., Seviour, R. J., Kuenen, J., & Jetten, M. (2000). Nitrous oxide (N₂O) production by *Alcaligenes faecalis* during feast and famine regimes. *Water Research*, 34(7), 2080-2088. [https://doi.org/10.1016/S0043-1354\(99\)00374-7](https://doi.org/10.1016/S0043-1354(99)00374-7)

-
- [83] Schmidt, I. (2008). Nitric oxide: interaction with the ammonia monooxygenase and regulation of metabolic activities in ammonia oxidizers. *Methods in enzymology*, 440, 121-135. [http://dx.doi.org/10.1016/S0076-6879\(07\)00807-5](http://dx.doi.org/10.1016/S0076-6879(07)00807-5)
- [84] Schmidt, I., & Bock, E. (1998). Anaerobic ammonia oxidation by cell-free extracts of *Nitrosomonas eutropha*. *Antonie van Leeuwenhoek*, 73(3), 271-278. <http://dx.doi.org/10.1023/A:1001572121053>
- [85] Shaw, L. J., Nicol, G. W., Smith, Z., Fear, J., Prosser, J. I., & Baggs, E. M. (2006). *Nitrosospira* spp. can produce nitrous oxide via a nitrifier denitrification pathway. *Environmental microbiology*, 8(2), 214-222. <https://doi.org/10.1111/j.1462-2920.2005.00882.x>
- [86] Shen, B., Jensen, R. G., & Bohnert, H. J. (1997). Mannitol protects against oxidation by hydroxyl radicals. *Plant physiology*, 115(2), 527-532. <https://doi.org/10.1104/pp.115.2.527>
- [87] Shen, L., Guan, Y., Wu, G., & Zhan, X. (2014). N₂O emission from a sequencing batch reactor for biological N and P removal from wastewater. *Frontiers of Environmental Science & Engineering*, 8(5), 776-783. <https://doi.org/10.1007/s11783-013-0586-0>
- [88] Sivret, E. C., Peirson, W. L., & Stuetz, R. M. (2008). Nitrous oxide monitoring for nitrifying activated sludge aeration control: A simulation study. *Biotechnology and Bioengineering*, 101(1), 109-118. <https://doi.org/10.1002/bit.21880>
- [89] Song, K., Harper, W. F., Hori, T., Riya, S., Hosomi, M., & Terada, A. (2015). Impact of carbon sources on nitrous oxide emission and microbial community structure in an anoxic/oxic activated sludge system. *Clean Technologies and Environmental Policy*, 17(8), 2375-2385. <https://doi.org/10.1007/s10098-015-0979-9>
- [90] Stein, L. Y. (2011). Surveying N₂O-producing pathways in bacteria. *Methods in enzymology*, 486, 131-152. <http://dx.doi.org/10.1016/B978-0-12-381294-0.00006-7>
- [91] Sun, S., Bao, Z., & Sun, D. (2015). Study on emission characteristics and reduction strategy of nitrous oxide during wastewater treatment by different processes. *Environmental Science and Pollution Research*, 22(6), 4222-4229. <https://doi.org/10.1007/s11356-014-3654-5>
- [92] Sun, S., Cheng, X., Li, S., Qi, F., Liu, Y., & Sun, D. (2013). N₂O emission from full-scale urban wastewater treatment plants: a comparison between A₂O and SBR. *Water Science and Technology*, 67(9), 1887-1893. <https://doi.org/10.1016/j.ibiod.2013.03.034>

-
- [93] Tallec, G., Garnier, J., Billen, G., & Gossiaux, M. (2006). Nitrous oxide emissions from secondary activated sludge in nitrifying conditions of urban wastewater treatment plants: effect of oxygenation level. *Water Research*, 40(15), 2972-2980. <https://doi.org/10.1016/j.watres.2006.05.037>
- [94] Tamimi, A., Rinker, E. B., & Sandall, O. C. (1994). Diffusion coefficients for hydrogen sulfide, carbon dioxide, and nitrous oxide in water over the temperature range 293-368 K. *Journal of Chemical and Engineering data*, 39(2), 330-332. <https://doi.org/10.1021/jc00014a031>
- [95] Thakur, I. S., & Medhi, K. (2019). Nitrification and denitrification processes for mitigation of nitrous oxide from waste water treatment plants for biovalorization: Challenges and opportunities. *Bioresource Technology*, 282, 502-513. <https://doi.org/10.1016/j.biortech.2019.03.069>
- [96] Thwaites, B. J., Reeve, P., Dinesh, N., Short, M. D., & van den Akker, B. (2017). Comparison of an anaerobic feed and split anaerobic-aerobic feed on granular sludge development, performance and ecology. *Chemosphere*, 172, 408-417. <http://dx.doi.org/10.1016/j.chemosphere.2016.12.133>
- [97] Thwaites, B. J., Stuetz, R., Short, M., Reeve, P., Alvarez-Gaitan, J.-P., Dinesh, N., Philips, R., & van den Akker, B. (2021). Analysis of nitrous oxide emissions from aerobic granular sludge treating high saline municipal wastewater. *Science of the Total Environment*, 756, 143653. <https://doi.org/10.1016/j.scitotenv.2020.143653>
- [98] Toyoda, S., Suzuki, Y., Hattori, S., Yamada, K., Fujii, A., Yoshida, N., Kouno, R., Murayama, K., & Shiomi, H. (2011). Isotopomer analysis of production and consumption mechanisms of N₂O and CH₄ in an advanced wastewater treatment system. *Environmental Science & Technology*, 45(3), 917-922. <https://doi.org/10.1021/es102985u>
- [99] Tumendelger, A., Toyoda, S., & Yoshida, N. (2014). Isotopic analysis of N₂O produced in a conventional wastewater treatment system operated under different aeration conditions. *Rapid Communications in Mass Spectrometry*, 28(17), 1883-1892. <http://dx.doi.org/10.1002/rcm.6973>
- [100] Vajrala, N., Martens-Habbena, W., Sayavedra-Soto, L. A., Schauer, A., Bottomley, P. J., Stahl, D. A., & Arp, D. J. (2013). Hydroxylamine as an intermediate in ammonia oxidation by globally abundant marine archaea. *Proceedings of the National Academy of Sciences*, 110(3), 1006-1011. <https://doi.org/10.1073/pnas.1214272110>

-
- [101] Valkova, T., Parravicini, V., Saracevic, E., Tauber, J., Svoldal, K., & Krampe, J. (2021). A method to estimate the direct nitrous oxide emissions of municipal wastewater treatment plants based on the degree of nitrogen removal. *Journal of Environmental Management*, 279, 111563. <https://doi.org/10.1016/j.jenvman.2020.111563>
- [102] Van Den Akker, B., Reid, K., Middlemiss, K., & Krampe, J. (2015). Evaluation of granular sludge for secondary treatment of saline municipal sewage. *Journal of Environmental Management*, 157, 139-145. <http://dx.doi.org/10.1016/j.jenvman.2015.04.027>
- [103] Van Kessel, M. A., Speth, D. R., Albertsen, M., Nielsen, P. H., Op den Camp, H. J., Kartal, B., Jetten, M. S., & Lücker, S. (2015). Complete nitrification by a single microorganism. *Nature*, 528(7583), 555-559. <https://doi.org/10.1038/nature16459>
- [104] Van Niel, E., Arts, P., Wesselink, B., Robertson, L., & Kuenen, J. (1993). Competition between heterotrophic and autotrophic nitrifiers for ammonia in chemostat cultures. *FEMS Microbiology Ecology*, 11(2), 109-118. [https://doi.org/10.1016/0378-1097\(93\)90006-N](https://doi.org/10.1016/0378-1097(93)90006-N)
- [105] Vangsgaard, A. K., Mauricio-Iglesias, M., Valverde-Pérez, B., Gernaey, K. V., & Sin, G. (2013). pH variation and influence in an autotrophic nitrogen removing biofilm system using an efficient numerical solution strategy. *Water Science and Technology*, 67(11), 2608-2615. <https://doi.org/10.2166/wst.2013.174>
- [106] Vasilaki, V., Massara, T., Stanchev, P., Fatone, F., & Katsou, E. (2019). A decade of nitrous oxide (N₂O) monitoring in full-scale wastewater treatment processes: a critical review. *Water Research*, 161, 392-412. <https://doi.org/10.1016/j.watres.2019.04.022>
- [107] Walker, C. B., De La Torre, J., Klotz, M., Urakawa, H., Pinel, N., Arp, D., Brochier-Armanet, C., Chain, P., Chan, P., & Gollabgir, A. (2010). Nitrosopumilus maritimus genome reveals unique mechanisms for nitrification and autotrophy in globally distributed marine crenarchaea. *Proceedings of the National Academy of Sciences*, 107(19), 8818-8823. <https://doi.org/10.1073/pnas.0913533107>
- [108] Wang, J., Zhang, J., Wang, J., Qi, P., Ren, Y., & Hu, Z. (2011). Nitrous oxide emissions from a typical northern Chinese municipal wastewater treatment plant. *Desalination and Water Treatment*, 32(1-3), 145-152. <http://dx.doi.org/10.5004/dwt.2011.2691>
- [109] Wang, S., Zhao, J., Ding, X., & Li, X. (2020). Nitric oxide and nitrous oxide production in anaerobic/anoxic nitrite-denitrifying phosphorus removal process: effect of

- phosphorus concentration. *Environmental Science and Pollution Research*, 27(36), 45925-45937. <https://doi.org/10.1007/s11356-020-10499-4>
- [110] Wicht, H. (1996). A model for predicting nitrous oxide production during denitrification in activated sludge. *Water Science and Technology*, 34(5-6), 99-106. [https://doi.org/10.1016/0273-1223\(96\)00634-8](https://doi.org/10.1016/0273-1223(96)00634-8)
- [111] Wrage, N., Velthof, G. L., Van Beusichem, M. L., & Oenema, O. (2001). Role of nitrifier denitrification in the production of nitrous oxide. *Soil biology and Biochemistry*, 33(12-13), 1723-1732. [https://doi.org/10.1016/S0038-0717\(01\)00096-7](https://doi.org/10.1016/S0038-0717(01)00096-7)
- [112] Wunderlin, P., Mohn, J., Joss, A., Emmenegger, L., & Siegrist, H. (2012). Mechanisms of N₂O production in biological wastewater treatment under nitrifying and denitrifying conditions. *Water Research*, 46(4), 1027-1037. <https://doi.org/10.1016/j.watres.2011.11.080>
- [113] Xing, W., Yin, M., Lv, Q., Hu, Y., Liu, C., & Zhang, J. (2014). Oxygen solubility, diffusion coefficient, and solution viscosity *Rotating electrode methods and oxygen reduction electrocatalysts* (<https://doi.org/10.1016/B978-0-444-63278-4.00001-X>pp. 1-31): Elsevier.
- [114] Yu, R., & Chandran, K. (2010a). Strategies of *Nitrosomonas europaea* 19718 to counter low dissolved oxygen and high nitrite concentrations. *BMC microbiology*, 10(1), 1-11. Retrieved from <http://www.biomedcentral.com/1471-2180/10/70>
- [115] Yu, R., Kampschreur, M. J., Loosdrecht, M. C. v., & Chandran, K. (2010b). Mechanisms and specific directionality of autotrophic nitrous oxide and nitric oxide generation during transient anoxia. *Environmental Science & Technology*, 44(4), 1313-1319. <https://doi.org/10.1021/es902794a>
- [116] Zhang, X., Wang, X., Zhang, J., Huang, X., Wei, D., Lan, W., & Hu, Z. (2016). Reduction of nitrous oxide emissions from partial nitrification process by using innovative carbon source (mannitol). *Bioresource Technology*, 218, 789-795. <http://dx.doi.org/10.1016/j.biortech.2016.07.043>
- [117] Zhu, X., & Chen, Y. (2011). Reduction of N₂O and NO generation in anaerobic– aerobic (low dissolved oxygen) biological wastewater treatment process by using sludge alkaline fermentation liquid. *Environmental Science & Technology*, 45(6), 2137-2143. <https://dx.doi.org/10.1021/es102900h>
- [118] Zou, X., Zhou, Y., Gao, M., Yang, S., Mohammed, A., & Liu, Y. (2022). Effective N₂O emission control during the nitrification/denitrification treatment of ammonia rich

wastewater. *Journal of Environmental Chemical Engineering*, 10(2), 107234.
<https://doi.org/10.1016/j.jece.2022.107234>



Vietnamese-German University

APPENDIX

Table A.1. Suggested values for urbanization and degree of discharge pathway or method utilization for each income group for some countries of regions

	Urbanization (U)			Degree of utilization of treatment or discharge pathway or method for each income group (T_{ij})														
	Population fraction			U = Urban high income					U = Urban low income					U = rural				
Country	Rural	Urban-high	Urban-low	Septic tank	Latrine	Other	Sewer	None	Septic tank	Latrine	Other	Sewer	None	Septic tank	Latrine	Other	Sewer	None
Asia																		
China	0.59	0.12	0.29	0.18	0.08	0.07	0.67	0.0	0.14	0.10	0.03	0.53	0.20	0.0	0.47	0.50	0.0	0.30
India	0.71	0.06	0.23	0.18	0.08	0.07	0.67	0.0	0.14	0.10	0.03	0.53	0.20	0.0	0.47	0.10	0.10	0.33
Indonesia	0.54	0.12	0.34	0.18	0.08	0.0	0.74	0.0	0.14	0.10	0.03	0.53	0.20	0.0	0.47	0.0	0.10	0.43
Pakistan	0.65	0.07	0.28	0.18	0.08	0.0	0.74	0.0	0.14	0.10	0.03	0.53	0.20	0.0	0.47	0.0	0.10	0.43
Bangladesh	0.72	0.06	0.22	0.18	0.08	0.0	0.74	0.0	0.14	0.10	0.03	0.53	0.20	0.0	0.47	0.0	0.10	0.43
Japan	0.20	0.80	0.0	0.0	0.0	0.10	0.90	0.0	0.10	0.0	0.0	0.90	0.0	0.20	0.0	0.50	0.30	0.0

Africa																		
Nigeria	0.52	0.10	0.38	0.3	0.31	0.0	0.37	0.0	0.17	0.24	0.05	0.34	0.2	0.02	0.28	0.04	0.10	0.56
Kenya	0.62	0.08	0.30	0.32	0.31	0.0	0.37	0.0	0.17	0.24	0.05	0.34	0.2	0.02	0.28	0.04	0.10	0.56
Egypt	0.57	0.09	0.34	0.15	0.05	0.10	0.07	0.0	0.17	0.24	0.05	0.34	0.2	0.02	0.28	0.04	0.10	0.56
South Africa	0.39	0.12	0.49	0.15	0.15	0.0	0.70	0.0	0.17	0.24	0.05	0.34	0.2	0.10	0.28	0.04	0.10	0.48
North America																		
United States	0.22	0.78	0.0	0.05	0.0	0.0	0.95	0.0	NA	NA	NA	NA	NA	0.90	0.02	0.0	0.08	0.0
Canada	0.20	0.80	0.0	0.05	0.0	0.0	0.95	0.0	NA	NA	NA	NA	NA	0.90	0.02	0.0	0.08	0.0
Latin America and Caribbean																		
Mexico	0.25	0.19	0.56	0.0	0.20	0.0	0.80	0.0	0.0	0.40	0.0	0.40	0.20	0.0	0.45	0.0	0.10	0.45
Brazil	0.16	0.25	0.59	0.0	0.20	0.0	0.80	0.0	0.0	0.40	0.0	0.40	0.20	0.0	0.45	0.0	0.10	0.45

Europe																		
Germany	0.06	0.94	0.0	0.05	0.0	0.0	0.95	0.0	NA	NA	NA	NA	NA	0.20	0.0	0.0	0.80	0.0
Russia	0.27	0.73	0.0	0.10	0.0	0.0	0.90	0.0	NA	NA	NA	NA	NA	0.30	0.10	0.0	0.60	0.0
France	0.24	0.76	0.0	0.0	0.0	0.0	1.0	0.0	NA	NA	NA	NA	NA					
Italy	0.32	0.68	0.0	0.04	0.0	0.0	0.96	0.0	NA	NA	NA	NA	NA	0.42	0.0	0.0	0.58	0.0
United Kingdom	0.10	0.90	0.0	0.0	0.0	0.0	1.0	0.0	NA	NA	NA	NA	NA	0.37	0.0	0.0	0.63	0.0
Oceania																		
New Zealand and Australia	0.08	0.92	0.0	0.05	0.0	0.0	0.95	0.0	NA	NA	NA	NA	NA	0.90	0.02	0.0	0.08	0.0

AFFIDAVIT

Thesis Statement pursuant to § 22 paragraph 7 of General Examination Terms (GET) of the Technische Universität Darmstadt.

I herewith formally declare that I, Nguyen Phuong Dung, have written the submitted thesis independently pursuant to § 22 paragraph 7 of General Examination Terms of the TU Darmstadt. I did not use any outside support except for the quoted literature and other sources mentioned in the paper. I clearly marked and separately listed all of the literature and all of the other sources which I employed when producing this academic work, either literally or in content. This thesis has not been handed in or published before in the same or similar form.

I am aware, that in case of an attempt at deception based on plagiarism (§38 Abs. 2 GET), the thesis would be graded with 5,0 and counted as one failed examination attempt. The thesis may only be repeated once.



Vietnamese-German University

Date:

Signature:

____ December 14, 2022 ____

____ Nguyen Phuong Dung ____



Vietnamese-German University

